

FlowSol® S/S HE

RESOL®

Manual for the
specialised craftsman

Installation
Operation
Commissioning



11206109

Thank you for buying this RESOL product.
Please read this manual carefully to get the best performance from this unit.
Please keep this manual carefully.

en

Manual

www.resol.com

Safety advice

Please pay attention to the following safety advice in order to avoid danger and damage to people and property.

Instructions

Attention must be paid to the valid local standards, regulations and directives!

Information about the product

Proper usage

The pump station may only be used in the solar circuit of solar thermal systems in compliance with the technical data specified in these instructions. Due to its design the station must be mounted and operated as described in these instructions!

CE-Declaration of conformity

The product complies with the relevant directives and is therefore labelled with the CE mark. The Declaration of Conformity is available upon request, please contact RESOL.



Target group

These instructions are exclusively addressed to authorised skilled personnel. Only qualified electricians should carry out electrical works. Initial installation must be effected by qualified personnel named by the manufacturer.

Subject to technical change. Errors excepted.

© 20170215_11206109_FlowSol_S_HE.monen.indd

Description of symbols

WARNING! Warnings are indicated with a warning triangle!
→ They contain information on how to avoid the danger described.



Signal words describe the danger that may occur, when it is not avoided.

- **WARNING** means that injury, possibly life-threatening injury, can occur.
- **ATTENTION** means that damage to the appliance can occur.



Note

Notes are indicated with an information symbol.

→ Arrows indicate instruction steps that should be carried out.

Disposal

- Dispose of the packaging in an environmentally sound manner.
- Dispose of old appliances in an environmentally sound manner. Upon request we will take back your old appliances bought from us and guarantee an environmentally sound disposal of the devices.

Contents

1	Overview	3
2	Mounting the station.....	4
3	Flushing and filling the solar system.....	4
4	Ball valve positions	5
5	Draining the system	5
6	Non-return valve	5
7	Flowmeter	6
8	Maintenance.....	6
9	Safety devices.....	6
10	Accessories	7
11	Information about the pump	7

1 Overview

- Pre-assembled pump station
- Integrated controller from the DeltaSol® BS or DeltaSol® CS series
- Safety assembly with connection for the diaphragm-type expansion vessel, safety valve and pressure gauge
- Fill and drain valves
- Wall mounting bracket and mounting material
- Standard or high-efficiency pump

Technical data

Circulating pump:

FlowSol® S: Wilo ST 15/6 ECO or 15/7 ECO

FlowSol® S HE: Wilo Yonos PARA ST 15/7.0-PWM2

(ErP power consumption of the pump*: 23 W)

Safety valve: 6 bar

Pressure gauge: 0 ... 10 bar

Flowmeter: 1 ... 13 l/min

Non-return valves:

Opening pressure 40 mbar, openable

Connection to diaphragm-type expansion vessel: ¾" ET, flat sealing

Outlet safety valve: ¾" IT

Connections to the solar pipes: ¾" IT

Maximum temperature: 95 °C

Maximum pressure: 6 bar

Medium: Water with max. 50 % glycol

Dimensions: approx. 430 × 223 × 193 mm (with insulation)

Distance centres: 100 mm

Distance centre / wall: 67 mm

Material: Fittings: brass

Seals: AFM 34

Insulation: EPP foam

* 50% of the rated power consumption



Note

This pump station can be used with the heat transfer fluids Tyfocor L, L eco and LS.

Pump characteristics/pressure loss characteristics

FlowSol® S standard pumps

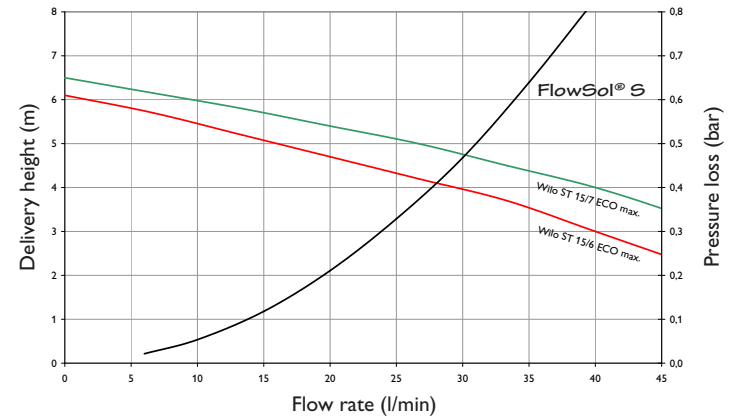

FlowSol® S HE high-efficiency pumps

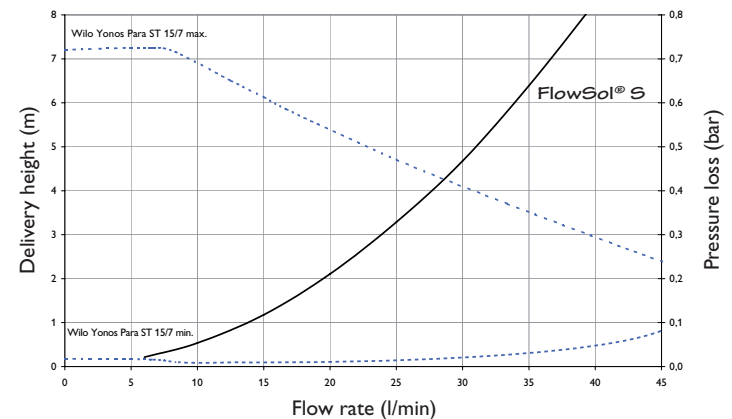

2 Mounting the station

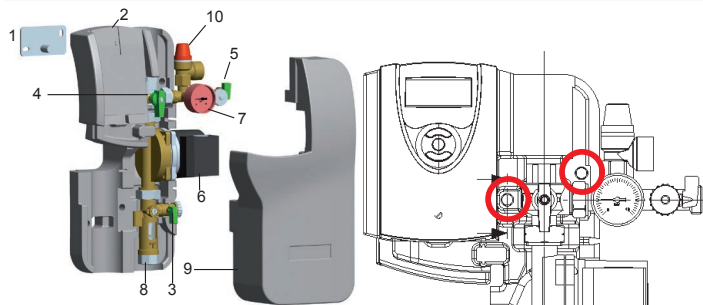

- 1 Wall mounting bracket
- 2 Back half of the insulation
- 3 Drain valve
- 4 Ball valve with integrated non-return valve
- 5 Fill valve
- 6 Pump
- 7 Pressure gauge
- 8 Flowmeter
- 9 Front half of the insulation
- 10 Safety valve 6 bar

- ➔ Determine the mounting site of the station.
- ➔ Mark the drill holes by means of the template enclosed, then drill and insert wall plugs (see figure to the right).
- ➔ Take the station out of the packaging.
- ➔ Remove the front half of the insulation. Leave the pump station attached to the back half of the insulation!
- ➔ Fasten the pump station to the wall with the enclosed screws. For this purpose, use a crosshead screw driver.
- ➔ Connect the pipework between pump station and store and collector respectively.



Note

All connections are already tightened such that they usually do not have to be tightened again. However, during commissioning of the system all connections have to be checked for leaks (pressure test).

3 Flushing and filling the solar system

WARNING!



Scald danger!

Pressure surge damage!

If the medium enters strongly heated, empty collectors, pressure surges caused by evaporation can occur.

- ➔ **In order to prevent the solar fluid from vaporising inside the collectors, do not fill or flush the system during times of strong irradiation!**

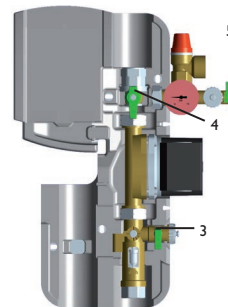

Before flushing the system

- ➔ Disconnect the expansion vessel from the solar thermal system.

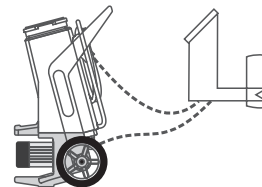

- ➔ Connect the pressure hose of the filling and flushing station to the fill valve (5) of the pump station.

- Connect the flushing hose of the filling and flushing station to the drain valve (3) of the pump station.



- Close the ball valve of the pump station (4).
- Open the fill valve (5) and the drain valve (3).
- Switch on the filling pump of the filling and flushing station.
- Flush the solar thermal system for at least 15 minutes by means of the filling and flushing station until the discharged solar fluid is free of gas bubbles and dirt particles.
- During flushing, bleed the solar thermal system several times until the discharged solar fluid (e.g. Tyfocor®, see chap. 10) is free of air bubbles.
- Open the ball valve (4) of the pump station.

After flushing the system

- Connect the expansion vessel to the solar thermal system
- Close the drain valve (3) of the pump station while the filling pump is running.



- Increase system pressure (approx. 3.5-4 bar). The system pressure can be read from the pressure gauge.
- Close the fill valve (5).
- Switch off the filling pump.
- Check the pressure gauge to see whether the system pressure reduces and eliminate leaks where necessary.
- Slowly discharge the heat transfer fluid by means of the drain valve (3) until the operating pressure is set.
- Remove the hoses of the filling and flushing station and screw the caps onto the fill and drain valves. Manually start the solar thermal pump at maximum speed (see controller manual) and let the fluid circulate for at least 15 minutes.
- Bleed the solar thermal system several times.

- Check the system pressure at the pressure gauge.



- Check the antifreeze ratio (not required if a ready-mix is used).

4 Ball valve positions



Ball valve closed, no fluid flow



Ball valve open, fluid flow in both directions possible



Ball valve in operating position, fluid flow in flow direction only

5 Draining the system

- Open the ball valve (4).
- Open the air vent at the highest point of the system (above the collectors).
- Open the drain valve.

6 Non-return valve

- The non-return valve of the pump station is integrated into the ball valve above the circulating pump. It has an opening pressure of 20 mbar.
- In order to completely drain the system, the non-return valve has to be opened. For this purpose, turn the handle of the ball valve by 45°.
- For normal system operation, open the ball valve completely.
- In order to avoid in-pipe-circulation, the flow line has to be equipped with a thermosiphon or an additional non-return valve.

7 Flowmeter

The flowmeter measures and indicates the flow rate with a range of 1-13 l/min. For the device to function faultlessly, the system must be flushed and free of grit.

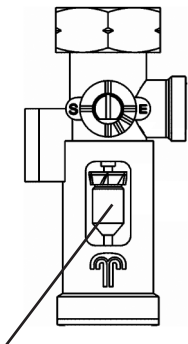

Read the flow rate from the upper edge of the float.

8 Maintenance

In the case of maintenance (such as a replacement of the pump) proceed as follows:

- ➔ Close the ball valve (4).
- ➔ Turn the slot of the flowmeter spindle by 90° anti-clockwise (see figure below).

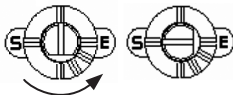

The heat transfer fluid can now be drained from the pump.

- ➔ Open the drain valve (3).
- If necessary, open the union nut at the pressure side.
- ➔ Now dismantle the pump.

9 Safety devices

The pump station is equipped with a diaphragm safety valve which corresponds to the relevant directives and regulations. For installation and operation, please pay attention to the following advice:

- The safety valve has to be easily accessible. The efficiency of the valve must not be influenced or disabled by barriers!
- The strainer or other restriction devices must not be mounted between collector (-field) and safety valve!
- The diameter of the discharge pipe must correspond to the diameter of the valve outlet; the maximum length must not exceed 2 m; more than 2 bends are inadmissible. When these values are exceeded, you have to install a discharge pipe with larger dimensions. Do not use more than 3 bends and pipes longer than 4 m!
- If the discharge pipe leads into a drain pipe with a funnel, the diameter of the drain pipe has to be at least twice as large as the valve inlet. The opening of the discharge pipe must be inclined downwards. It must be routed such that the opening can be seen but does not present any risk to a person standing or passing by.
- We recommend placing a container below the discharge pipe. If the safety valve opens, the fluid will be collected and can be refilled into the system when the pressure is too low.

10 Accessories

SBS 2000 filling and flushing station

The SBS 2000 has been especially designed for professionally filling and flushing solar thermal and heating systems. Its many thought-out details facilitate transport, operation and cleaning, the attractive design makes it the ideal companion for a professional performance.



Heat transfer fluids

In our product portfolio, you will find a range of heat transfer fluids for different applications, available as readymix or concentrate.



Note

This pump station can be used with the heat transfer fluids Tyfocor L, L eco and LS.

Wall mounting for diaphragm-type expansion vessel

Wall mounting for diaphragm-type expansion vessel with screws and wall plugs, high grade steel corrugated tube and connection thread $\frac{3}{4}$ ". Including quick release valve coupling enabling removal of expansion without draining down of the system.



ALS15 discharge hose

1.5 m hose for connection to the safety valve of the FlowSol® S/S HE pump station.

See our full range of accessories on our website:

www.resol.com

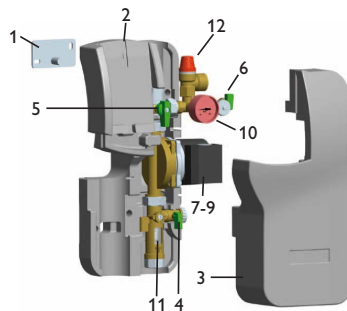

Lists of spare parts

Pos.	Art. no.	Article
1	11200052	Wall mounting bracket
2	70001512	Back half of the insulation
3	70001511	Front half of the insulation
4	11200067	Drain valve
5	11200060	Ball valve with integrated non-return valve
6	11200058	Fill valve
7	28000610	Pump WILO ST 15/6
8	or 28000620	Pump WILO ST 15/7
9	or 11204195	Pump WILO Yonos Para ST 15/7 (HE Pump)
10	11200039	Pressure gauge (10 bar)
11	28000490	Flowmeter
12	11200054	Safety valve 6 bar

11 Information about the pump

Depending on the version, the station is equipped with different pumps. Data concerning the pump in your station are available at the pump manufacturer under www.wilointec.com.

Upon request we will provide you with further information.

Distributed by:

RESOL - Elektronische Regelungen GmbH

Heiskampstraße 10
45527 Hattingen / Germany

Tel.: +49 (0) 23 24 / 96 48 - 0

Fax: +49 (0) 23 24 / 96 48 - 755

www.resol.com

info@resol.com

Important note

The texts and drawings in this manual are correct to the best of our knowledge. As faults can never be excluded, please note:

Your own calculations and plans, under consideration of the current standards and directions should only be basis for your projects. We do not offer a guarantee for the completeness of the drawings and texts of this manual - they only represent some examples. They can only be used at your own risk. No liability is assumed for incorrect, incomplete or false information and/or the resulting damages.

Note

The design and the specifications can be changed without notice.
The illustrations may differ from the original product.

Imprint

This mounting- and operation manual including all parts is copyrighted. Another use outside the copyright requires the approval of RESOL – Elektronische Regelungen GmbH. This especially applies for copies, translations, micro films and the storage into electronic systems.

© **RESOL – Elektronische Regelungen GmbH**