

DeltaSol[®] BS/2

(Version 2)

RESOL[®]

Solar controller

Manual for the
specialised craftsman

Installation

Operation

Functions and options

Troubleshooting



48005952

Thank you for buying this RESOL product.
Please read this manual carefully to get the best performance from this unit.
Please keep this manual safe.

en

Manual

www.resol.com

Safety advice

Please pay attention to the following safety advice in order to avoid danger and damage to people and property.

Instructions

Attention must be paid to the valid local standards, regulations and directives!

Information about the product

Proper usage

The solar controller is designed for electronically controlling standard solar thermal systems in compliance with the technical data specified in this manual.

Improper use excludes all liability claims.

CE Declaration of conformity

The product complies with the relevant directives and is therefore labelled with the CE mark. The Declaration of Conformity is available on request, please contact the manufacturer.



Note:

Strong electromagnetic fields can impair the function of the controller.

- Make sure the controller as well as the system are not exposed to strong electromagnetic fields.

Target group

These instructions are exclusively addressed to authorised skilled personnel.

Only qualified electricians are allowed to carry out electrical works.

Initial commissioning must be effected by the system installer or qualified personnel named by the system installer.

Description of symbols

WARNING! Warnings are indicated with a warning triangle!



→ They contain information on how to avoid the danger described.

Signal words describe the danger that may occur, when it is not avoided.

- **WARNING** means that injury, possibly life-threatening injury, can occur.
- **ATTENTION** means that damage to the appliance can occur.



Note:

Notes are indicated with an information symbol.

- Arrows indicate instruction steps that should be carried out.

Disposal

- Dispose of the packaging in an environmentally sound manner.
- At the end of its working life, the product must not be disposed of as urban waste. Old appliances must be disposed of by an authorised body in an environmentally sound manner. Upon request we will take back your old appliances bought from us and guarantee an environmentally sound disposal of the devices.



Subject to technical change. Errors excepted.

The RESOL controller for standard solar thermal systems.

The DeltaSol® BS controller provides a clear operating concept and is equipped with the illuminated combined display with system-monitoring. Flashing symbols for sensors, pumps and valves enable an immediate allocation of temperatures, temperature differences and active actuators. Thus, adjusting and monitoring the solar system is quick and easy.

Contents

1	Overview	4
2	Installation	5
2.1	Mounting.....	5
2.2	Electrical connection.....	6
2.3	Data communication / Bus.....	6
2.4	System: Standard solar system with 1 store.....	7
3	Operation and function	9
3.1	Buttons.....	9
4	System-Monitoring-Display	9
4.1	System screen.....	10
4.2	Other indications.....	10
5	Commissioning.....	11
6	Channel overview	12
6.1	Display channels	12
6.2	Adjustment channels.....	14
7	Troubleshooting.....	22
8	Accessories	25
8.1	Sensors and measuring instruments.....	26
8.2	VBus® accessories.....	26
8.3	Interface adapters	26
9	Index	27

1 Overview

- Drainback option
- Heat quantity measurement
- Commissioning menu
- Unit °F and °C selectable
- HE pump control via adapter

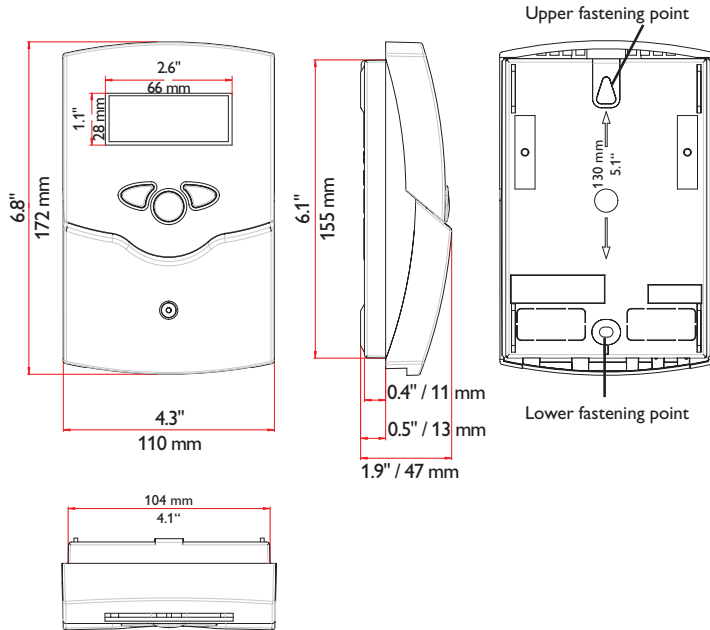

Technical data

Inputs: 4 Pt1000 temperature sensors

Outputs: 1 semiconductor relay

Switching capacity: 1 (1) A 240 V~ (semiconductor relay)

Total switching capacity: 1 A 240 V~

Power supply: 100–240 V~ (50–60 Hz)

Supply connection: type Y attachment

Standby: 0.45 W

Mode of operation: type 1.C.Y action

Rated impulse voltage: 2.5 kV

Data interface: RESOLVBus®

VBus® current supply: 35 mA

Functions: Differential temperature controller with optional add-on system functions. Function control, operating hours counter, heat quantity measurement and speed control

Housing: plastic, PC-ABS and PMMA

Mounting: wall mounting, also suitable for mounting into patch panels

Indication/Display: System-Monitoring-Display for visualisation of systems, 16-segment and 7-segment display, 8 symbols for indication of system status and operating control lamp

Operation: 3 push buttons at the front of the housing

Protection type: IP 20/EN 60529

Protection class: II

Ambient temperature: 0... 40 °C

Degree of pollution: 2

Dimensions: 172 x 110 x 49 mm

2 Installation

2.1 Mounting

WARNING! Electric shock!



Upon opening the housing, live parts are exposed!

→ **Always disconnect the device from power supply before opening the housing!**



Note:

Strong electromagnetic fields can impair the function of the controller.

→ Make sure the controller as well as the system are not exposed to strong electromagnetic fields.

The device must only be located in dry interior rooms.

The controller must additionally be supplied from a double pole switch with contact gap of at least 3 mm.

Please pay attention to separate routing of sensor cables and mains cables.

In order to mount the device to the wall, carry out the following steps:

- Unscrew the crosshead screw from the cover and remove it along with the cover from the housing.
- Mark the upper fastening point on the wall. Drill and fasten the enclosed wall plug and screw leaving the head protruding.
- Hang the housing from the upper fastening point and mark the lower fastening point (centres 130 mm).
- Insert lower wall plug.
- Fasten the housing to the wall with the lower fastening screw and tighten.
- Carry out the electrical wiring in accordance with the terminal allocation (see page 6).
- Put the cover on the housing.
- Attach with the fastening screw.

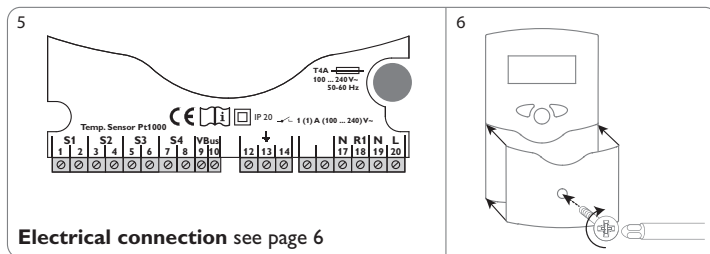
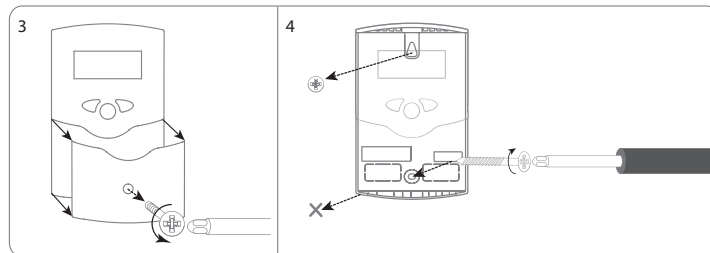
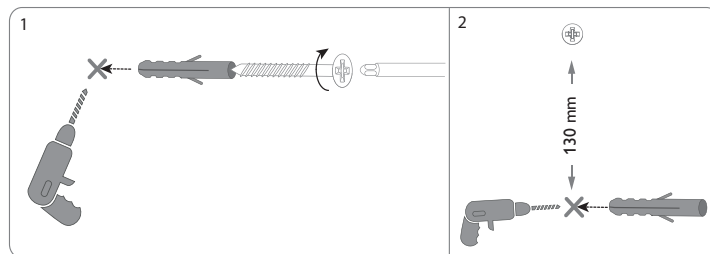

2.2 Electrical connection

WARNING! Electric shock!



Upon opening the housing, live parts are exposed!

→ **Always disconnect the device from power supply before opening the housing!**

ATTENTION! ESD damage!



Electrostatic discharge can lead to damage to electronic components!

→ **Take care to discharge properly before touching the inside of the device!**



Note:

The pump speed must be set to 100% when auxiliary relays or valves are connected.



Note:

Connecting the device to the power supply must always be the last step of the installation!



Note:

It must be possible to disconnect the device from the mains at any time.

- Install the mains plug such that it is accessible at any time.
- If this is not possible, install a switch that can be accessed.

Do not use the device if it is visibly damaged!

The power supply of the controller must be carried out via an external power supply switch. The power supply of the device must be 100...240V~ (50...60Hz). Attach flexible cables to the housing with the enclosed strain relief and the corresponding screws.

The controller is equipped with 1 semiconductor relay to which a load such as a pump, a valve, etc. can be connected:

- Relay 1
 - 18 = Conductor R1
 - 17 = Neutral conductor N
 - 13 = Grounding terminal

The **mains connection** is at the following terminals:

- 19 = Neutral conductor N
- 20 = Conductor L
- 12 = Grounding terminal ⚡

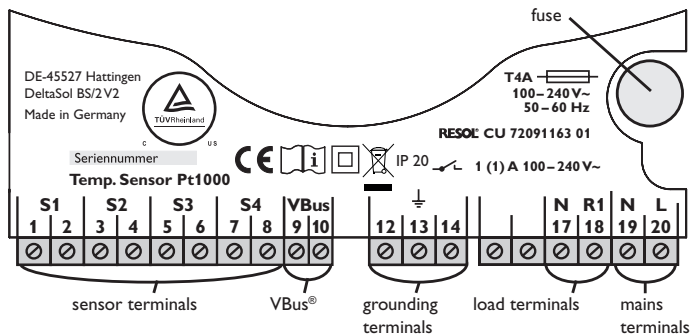

Connect the **temperature sensors** (S1 to S4) to the corresponding terminals with either polarity:

1/2 = Sensor 1 (e.g. collector sensor)

3/4 = Sensor 2 (e.g. store sensor)

5/6 = Sensor 3 (e.g. store sensor top)

7/8 = Sensor 4 (e.g. return sensor)

2.3 Data communication / Bus

The controller is equipped with a **RESOL VBus®** for data transfer and energy supply to external modules. The connection is to be carried out at the terminals marked **VBus** (any polarity).

One or more **RESOL VBus®** modules can be connected via this data bus, such as:

- RESOL DL2 Datalogger
- RESOL DL3 Datalogger
- VBus®/PWM interface adapter

Furthermore, the controller can be connected to a PC or integrated into a network via the RESOL VBus®/USB or VBus®/LAN interface adapter (not included). Different solutions for visualisation and remote parameterisation are available on the RESOL website www.resol.com.



Note:

More accessories on page 25.

2.4 System: Standard solar system with 1 store

The controller calculates the temperature difference between collector sensor S1 and store sensor S2. If the difference is larger than or identical to the adjusted switch-on temperature difference (DTO), the solar pump will be activated by the relay, and the store will be loaded until the switch-off temperature difference (DTF) or the maximum store temperature (SMX) is reached.

Sensors S3 and S4 can optionally be connected for measurement purposes. S3 can optionally be used as the reference sensor for the store emergency shutdown option (OSEM).

If heat quantity measurement (OHQM) is activated, S4 is to be used as the return sensor:

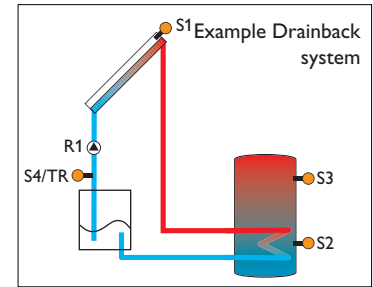
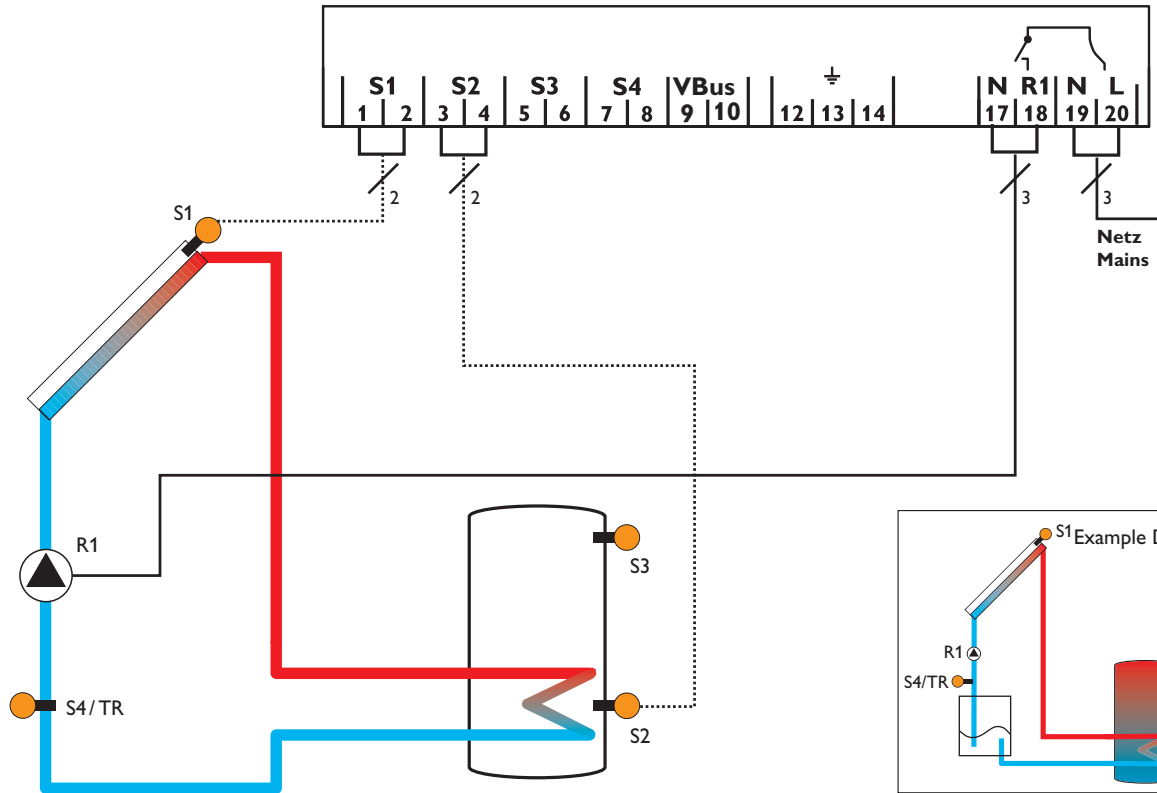
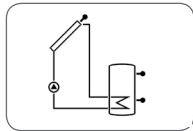

Display channels

Channel		Description	Connection terminal	Page
INIT	x*	ODB initialisation active	-	12
FLL	x*	ODB filling time active	-	12
STAB	x*	ODB stabilisation in progress	-	12
COL	x	Temperature collector	S1	12
TST	x	Temperature store	S2	12
S3	x	Temperature sensor 3	S3	12
TSTT	x*	Temperature store top	S3	13
S4	x	Temperature sensor 4	S4	12
TR	x*	Temperature return sensor	S4	13
n %	x	Speed R1	R1	13
hP	x	Operating hours R1	R1	13
kWh	x*	Heat quantity in kWh	-	13
MWh	x*	Heat quantity in MWh	-	13

Legend:

Symbol	Description
x	Channel is available
x*	Channel is available, if the corresponding option is activated.

Adjustment channels

Channel		Description	Factory setting	Page
DT O	x	Switch-on temperature difference	6.0K [12.0 °Ra]	14
DT F	x	Switch-off temperature difference	4.0K [8.0 °Ra]	14
DT S	x	Set temperature difference	10.0K [20.0 °Ra]	14
RIS	x	Rise	2K [4 °Ra]	15
nMN	x	Minimum speed	30%	15
S MX	x	Maximum store temperature	140 °F [60 °C]	15
OSEM	x	Store emergency shutdown option	OFF	16
		Collector emergency temperature	130 °C [270 °F]	16
EM	x	Collector emergency temperature if ODB is activated:	200 °F [95 °C]	16
OCC	x	Collector cooling option	OFF	16
CMX	x*	Maximum collector temperature	110 °C [230 °F]	16
OSYC	x	System cooling option	OFF	17
DTCO	x*	Switch-on temperature difference cooling	20.0K [40.0 °Ra]	17
DTCF	x*	Switch-off temperature difference cooling	15.0K [30.0 °Ra]	17
OSTC	x	Store cooling option	OFF	17
OHOL	x*	Holiday cooling option	OFF	17
THOL	x*	Holiday cooling temperature	40 °C [110 °F]	17
OCN	x	Collector minimum limitation option	OFF	18
CMN	x*	Collector minimum temperature	10 °C [50 °F]	18
OCF	x	Antifreeze option	OFF	18
CFR	x*	Antifreeze temperature	4.0 °C [40.0 °F]	18
OHQM	x	Heat quantity measurement option	OFF	18
FMAX	x*	Maximum flow rate	6.0 l	18
MEDT	x*	Antifreeze type	1	18
MED%	x*	Antifreeze concentration(only if MEDT = propylene or ethylene glycol)	45 %	18
ODB	x	Drainback option	OFF	19
tDTO	x*	ODB switch-on condition - time period	60 s	19
tFLL	x*	ODB filling time	5.0 min	19
tSTB	x*	ODB stabilisation time	2.0 min	19
MAN1	x	Manual mode R1	Auto	20
ADA1	x	HE pump control	OFF	20
LANG	x	Language	dE	20
UNIT	x	Temperature unit	°C	20
RESE	x	Reset - back to factory settings		21
W002#####		Version number		

3 Operation and function

3.1 Buttons

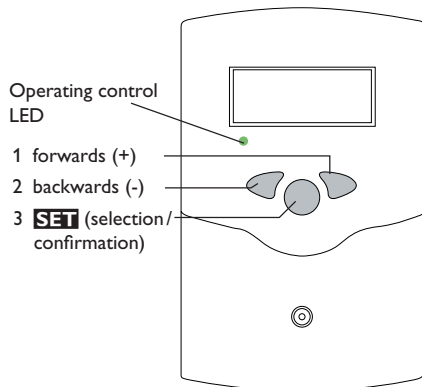

The controller is operated via the 3 push buttons below the display.

Button 1 (+) - scrolling forwards, increasing adjustment values.

Button 2 (-) - scrolling backwards, reducing adjustment values.

Button 3 (OK) - confirming/selecting.

During normal operation, display channels will be displayed.

→ In order to scroll between display channels, press buttons 1 and 2.

Access to adjustment channels:

→ Use button 1 in order to scroll to the last display channel, then press and hold down button 1 for approx. 2 s.

If an **adjustment channel** is shown on the screen, **SET** will be displayed on the right-hand side next to the channel name.

→ Press button 3 in order to select an adjustment channel.

SET starts flashing.

→ Adjust the desired value with buttons 1 and 2.

→ Briefly press button 3.

SET permanently appears, the adjusted value has been saved.

4 System-Monitoring-Display

System-Monitoring-Display



The System-Monitoring-Display consists of 3 blocks: channel display, tool bar and system screen.

Channel display

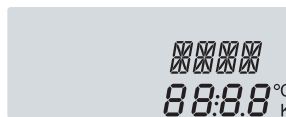

The channel display consists of 2 lines. The upper display line is an alphanumeric 16-segment display. In this line, mainly channel names and menu items are displayed. In the lower 16-segment display, values are displayed.

Tool bar

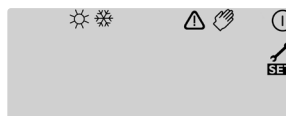

The additional symbols in the tool bar indicate the current system state.

4.1 System screen

The system selected is indicated in the System-Monitoring-Display. It consists of several system component symbols which are – depending on the current status of the system – either flashing, permanently shown or not indicated.

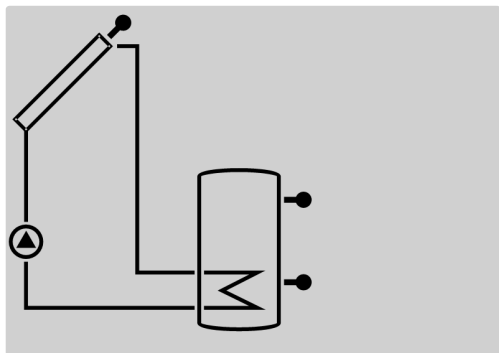

Collector
with collector sensor



Temperature sensor



Store
with heat exchanger



Pump

4.2 Other indications

System screen

- Pump symbol is flashing when the relay is active.
- Sensor symbols are flashing, if the corresponding sensor display channel is selected
- Sensors are flashing quickly in the case of a sensor fault

Operating control LED

Green: Everything OK

Red / green flashing: Initialisation active

Red flashing: Manual mode

Sensor fault (sensor symbol is flashing quickly)

Permanently shown	Flashing	Status indications:
ⓘ		Relay 1 active
☼		Maximum store temperature exceeded
	⚠ + ☼	Store emergency shutdown active
	⚠	Collector emergency shutdown active
ⓘ	☼	Collector cooling active
ⓘ	☼	System cooling active
ⓘ + ☼		Store cooling active
☼	⚠	Holiday cooling option activated
ⓘ + ☼	⚠	Holiday cooling active
	☼	Collector minimum limitation active
☼		Antifreeze function activated
ⓘ	☼	Antifreeze function active
👉 + ⓘ	⚠	Manual mode relay 1 ON
👉	⚠	Manual mode relay 1 OFF
🔧	⚠	Sensor fault

5 Commissioning

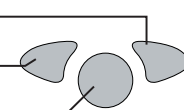
- 1 forwards (+)
 - 2 backwards (-)
 - 3 **SET** (selection/confirmation)
- 

→ Connect the device to the mains

The controller runs an initialisation phase in which the operating control LED flashes red/green.

When the controller is commissioned or when it is reset, it will run a commissioning menu. The commissioning menu leads the user through the most important adjustment channels needed for operating the system.

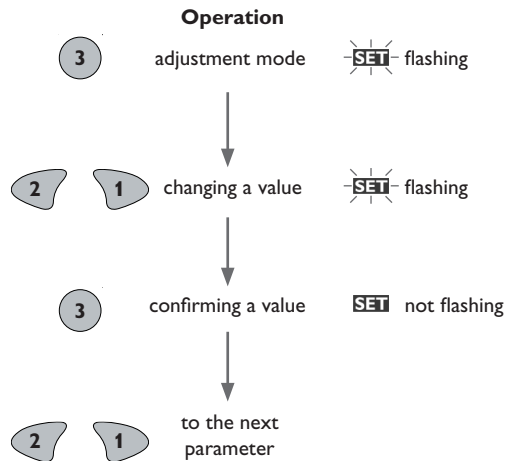

Commissioning

1. Language

→ Adjust the desired menu language.

LANG

Language selection
Selection: dE, En, Fr
Factory setting: dE

2. Temperature unit

→ Adjust the desired unit.

UNIT

Temperature unit
Selection: °F, °C
Factory setting: °C

3. Maximum store temperature

→ Adjust the maximum store temperature.

SMX

Adjustment range: 4... 95 °C [40... 200 °F]
Factory setting: 60 °C [140 °F]



Note:

The controller is also equipped with a non-adjustable emergency shutdown, deactivating the system if the store reaches 95 °C [200 °F].

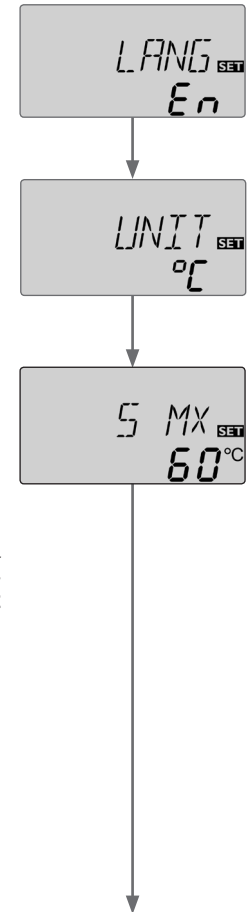

Commissioning

4. Minimum speed

➔ Adjust the minimum speed for the corresponding pump.

nMN

Speed control

Adjustment range: 30 ... 100 %

Factory setting: 30



Note:

The pump speed must be set to 100% when auxiliary relays or valves are connected.

Confirmation

Completing the commissioning menu

After the last channel of the commissioning menu has been adjusted and confirmed, the controller asks for confirmation of the adjustments.

➔ In order to confirm the adjustments made in the commissioning menu, press button 3.

The controller is then ready for operation and normally the factory settings will give close to optimum operation.



Note:

The adjustments carried out during commissioning can be changed anytime in the corresponding adjustment channel. Additional functions and options can also be activated or deactivated (see page 14).

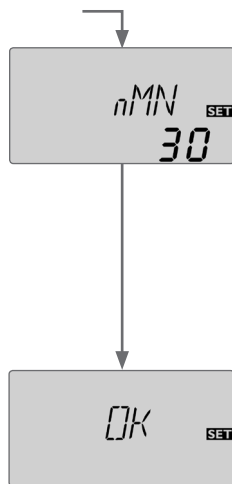

6 Channel overview

6.1 Display channels



Note:

The displayed values and adjustment channels depend on which options and functions have been selected. Only values and adjustment channels available for the individual settings selected will appear in the menu.

Display of drainback time periods

Initialisation



INIT

ODB initialisation active

Indicates the time adjusted in tD*TO*, running backwards.

Filling time



FLL

ODB filling time active

Indicates the time adjusted in tFLL, running backwards.

Stabilisation

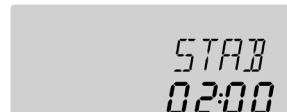

STAB

ODB stabilisation in progress

Indicates the time adjusted in tSTB, running backwards.

Display of collector temperatures



COL

Collector temperature

Display range: -40 ... +260 °C [-40 ... +500 °F]

Indicates the collector temperature.

Display of store temperatures

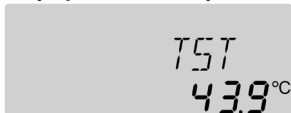

TST

Store temperature

Display range: -40 ... +260 °C [-40 ... +500 °F]

Indicates the store temperature.

Indication of sensors 3 and 4

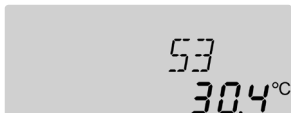

S3, S4

Sensor temperatures

Display range: -40 ... +260 °C [-40 ... +500 °F]

Indicates the current temperature at the corresponding additional sensor (without control function).

- S3: Temperature at sensor 3
- S4: Temperature at sensor 4



Note:

S3 and S4 will only be indicated if the temperature sensors are connected to the corresponding terminals.

Indication of return temperature



TR

Return temperature

Display range: -40 ... +260 °C [-40 ... +500 °F]

If the heat quantity measurement is activated, the temperature at sensor S4 will be indicated as TR.

Indication of current pump speed

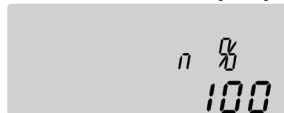

n%

Current pump speed

Display range: 30 ... 100%

Indicates the current pump speed.

Display of heat quantity



kWh/MWh

Heat quantity in kWh/MWh

Display channel

Indicates the heat quantity produced in the system. For this purpose, the heat quantity measurement option has to be enabled. The flow rate as well as the values of the reference sensors flow and return are used for calculating the heat quantity supplied. It is shown in kWh in the **kWh** channel and in MWh in the **MWh** channel. The overall heat quantity results from the sum of both values.

The accumulated heat quantity can be set back to zero. As soon as one of the display channels of the heat quantity is selected, the symbol **SET** is displayed.

➔ In order to access the reset mode of the counter, press button 3 for approx. 2 s.

SET starts flashing and the heat quantity value will be set back to zero.

➔ In order to finish the reset process, press button 3.

In order to interrupt the reset process, do not press any button for about 5 s. The display returns to the display mode.

Operating hours counter

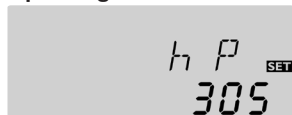

hP

Operating hours counter

Display channel

The operating hours counter accumulates the operating hours of the corresponding relay (**hP**).

Full hours are displayed.

The accumulated operating hours can be set back to zero. As soon as one of the display channels of the heat quantity is selected, the symbol **SET** is displayed.

➔ In order to access the reset mode of the counter, press button 3 for approx. 2 s.

SET starts flashing and the operating hours value will be set back to zero.

➔ In order to finish the reset process, press button 3.

In order to interrupt the reset process, do not press any button for about 5 s. The display returns to the display mode.

6.2 Adjustment channels

ΔT control

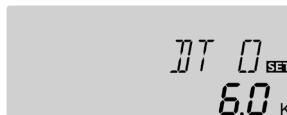

DTO

Switch-on temperature difference

Adjustment range: 1.0 ... 20.0 K [2.0 ... 40.0 °Ra]

Factory setting: 6.0 K [12.0 °Ra]

The controller works as a standard differential controller. If the temperature reaches or exceeds the switch-on temperature difference, the pump switches on. When the temperature difference reaches or falls below the adjusted switch-off temperature difference, the respective relay switches off.



Note:

The switch-on temperature difference must be at least 0.5 K [1 °Ra] higher than the switch-off temperature difference.

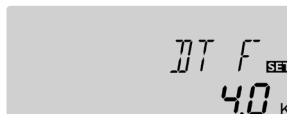

DTF

Switch-off temperature difference

Adjustment range: 0.5 ... 19.5 K [1.0 ... 39.0 °Ra]

Factory setting: 4.0 K [8.0 °Ra]



Note:

When the drainback option **ODB** is activated, the values of the parameters **DTO**, **DTF** and **DTS** will be adapted to values suiting drainback systems:

DTO = 10 K [20 °Ra]

DTF = 4 K [8 °Ra]

DTS = 15 K [30 °Ra]

Adjustments previously made in these channels will be overridden and have to be entered again if **ODB** is deactivated later on.

Speed control



DTS

Set temperature difference

Adjustment range: 1.5 ... 30.0 K [3.0 ... 60.0 °Ra]

Factory setting: 10.0K [20.0 °Ra]



Note:

For pump speed control, the operating mode of the corresponding relay must be set to **Auto** (adjustment channel **MAN**).



RIS

Rise

Adjustment range: 1 ... 20 K [2 ... 40 °Ra]

Factory setting: 2K [4 °Ra]

If the temperature difference reaches or exceeds the switch-on temperature difference, the pump switches on at 100% speed for 10 s. Then, the speed is reduced to the minimum pump speed value.

If the temperature difference reaches the adjusted set value, the pump speed increases by one step (10%). The response of the controller can be adapted via the parameter Rise. Each time the difference increases by the adjustable rise value, the pump speed increases by 10% until the maximum pump speed of 100% is reached. If the temperature difference decreases by the adjustable rise value, pump speed will be decreased by one step.



Note:

The set temperature difference must be at least 0.5K [1 °Ra] higher than the switch-on temperature difference.

Minimum speed

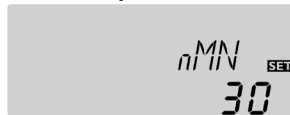

nMN

Speed control

Adjustment range: 30 ... 100%

Factory setting: 30%

If ODB is activated: 50%

A relative minimum pump speed can be allocated to the output R1 via the adjustment channel **nMN**.



Note:

The pump speed must be set to 100% when auxiliary relays or valves are connected.

Maximum store temperature



SMX

Maximum store temperature

Adjustment range: 4 ... 95 °C [40 ... 200 °F]

Factory setting: 60 °C [140 °F]

If the store temperature reaches the adjusted maximum temperature, the store will no longer be loaded in order to avoid damage caused by overheating. A non-adjustable hysteresis of 2K [4 °Ra] is set for the maximum store temperature.

If the maximum store temperature is exceeded, ☼ is displayed.



Note:

If the collector cooling or the system cooling function is activated, the adjusted maximum store temperature may be exceeded. In order to prevent system damage, the controller is also equipped with an integrated store emergency shutdown, deactivating the system if the store reaches 95 °C [200 °F].

Store emergency shutdown



OSEM SET
OFF

OSEM

Store emergency shutdown option

Adjustment range: ON, OFF

Factory setting: OFF

This option is used for activating the internal store emergency shutdown for an upper store sensor. If the temperature at the reference sensor exceeds 95 °C [200 °F], the store will be blocked and loading will be stopped until the temperature falls below 90 °C [190 °F].



Note:

S3 is used as the reference sensor.

Collector emergency shutdown



EM SET
130 °C

EM

Collector limit temperature

Adjustment range: 80 ... 200 °C [170 ... 390 °F]

Factory setting: 130 °C [270 °F]

When the collector temperature exceeds the adjusted collector limit temperature, the solar pump (R1) switches off in order to protect the system components against overheating (collector emergency shutdown). If the collector limit temperature is exceeded, Δ is displayed (flashing).



Note:

If the drainback option **ODB** is activated, the adjustment range of **EM** is changed to 80 ... 120 °C [170 ... 250 °F]. The factory setting in that case is 95 °C [200 °F].

Cooling functions

In the following the 3 cooling functions – collector cooling, system cooling and store cooling – are described in detail. The following note is valid for all 3 cooling functions:



Note:

The cooling functions will not become active as long as solar loading is possible.

Collector cooling



OCC SET
OFF

OCC

Collector cooling option

Adjustment range: OFF/ON

Factory setting: OFF



CMX SET
110 °C

CMX

Collector maximum temperature

Adjustment range: 70 ... 160 °C [150 ... 320 °F]

Factory setting: 110 °C [230 °F]

The collector cooling function keeps the collector temperature within the operating range by heating the store. If the store temperature reaches 95 °C [200 °F] the function will switch off for safety reasons.

If the store temperature exceeds the adjusted maximum store temperature, the solar system is switched off. If the collector temperature increases to the adjusted maximum collector temperature, the solar pump is activated until the collector temperature falls below the maximum collector temperature. The store temperature may then exceed the maximum temperature, but only up to 95 °C [200 °F] (emergency shutdown of the store).

If the collector cooling function is active, \odot and \star are displayed (flashing).



Note:

This function will only be available if the system cooling function (OSYC) is deactivated.

System cooling

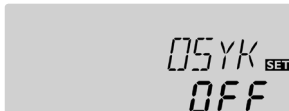

OSYK

System cooling option

Adjustment range: OFF/ON

Factory setting: OFF

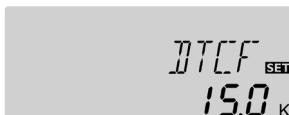

DTCF

Switch-off temperature difference

Adjustment range: 0.5 ... 29.5 K [1.0 ... 59.0 °Ra]

Factory setting: 15.0 K [30.0 °Ra]

The system cooling function aims to keep the solar system operational for a longer time. The function overrides the maximum store temperature to provide thermal relief of the collector field and the heat transfer fluid on hot days.

If the store temperature is higher than the adjusted maximum store temperature and the switch-on temperature difference **DTCO** is reached, the solar pump remains switched on or will be switched on. Solar loading is continued until either the temperature difference falls below the adjusted value **DTCF** or the collector limit temperature is reached.

If the system cooling function is active,  and  are displayed (flashing).



Note:

This function will only be available, if the collector cooling function (OCC) is deactivated.

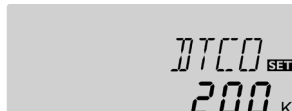

DTCO

Switch-on temperature difference

Adjustment range:

1.0 ... 30.0 K [2.0 ... 60.0 °Ra]

Factory setting: 20.0 K [40.0 °Ra]

Store cooling



OSTC

Store cooling option

Adjustment range: OFF/ON

Factory setting: OFF



THOL

Holiday cooling temperature

Adjustment range: 20 ... 80 °C [70 ... 175 °F]



Factory setting: 40 °C [110 °F]

When the store cooling function is activated, the controller aims to cool down the store during the night in order to prepare it for solar loading on the following day.

If the adjusted maximum store temperature **SMX** is exceeded and the collector temperature falls below the store temperature, the system will be reactivated in order to cool down the store. Cooling will continue until the store temperature has fallen below the adjusted maximum store temperature (**SMX**) again. A hysteresis of 2 K [4 °Ra] is set for the store cooling function.

Reference threshold temperature differences for the store cooling function are **DTO** and **DTF**.

If no DHW consumption is expected for a longer period of time, the additional holiday cooling option **OHOL** can be activated in order to extend the store cooling function. The adjustable temperature **THOL** then replaces the maximum store temperature (**SMX**) as the switch-off temperature for the store cooling function.

When the holiday cooling function is activated,  and  (flashing) are shown on the display.

If the holiday cooling function is active, ,  and  are displayed (flashing).

Collector minimum limitation

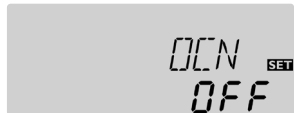

OCN

Collector minimum limitation option
Adjustment range: OFF/ON
Factory setting: OFF



CMN

Minimum collector temperature
Adjustment range:
10.0... 90.0 °C [50.0... 190.0 °F]
Factory setting: 10.0 °C [50.0 °F]

If the collector minimum limitation option is activated, the pump (R1) will only be switched on if the adjustable collector minimum temperature is exceeded. The minimum temperature prevents the pump from being switched on too often at low collector temperatures. A hysteresis of 5 K [10 °Ra] is set for this function.

If the collector minimum limitation is active, ❄️ is displayed (flashing).



Note:

If **OSTC** or **OCF** is active, the collector minimum limitation will be overridden. In that case, the collector temperature may fall below **CMN**.

Antifreeze function

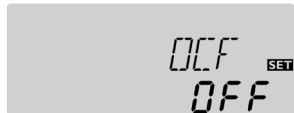

OCF

Antifreeze option
Adjustment range: OFF/ON
Factory setting: OFF



CFR

Antifreeze temperature
Adjustment range:
-40.0... +10.0 °C [-40.0... +50.0 °F]
Factory setting: +4.0 °C [+40.0 °F]

The antifreeze function activates the loading circuit between the collector and the store when the temperature falls below the adjusted antifreeze temperature. This will protect the fluid against freezing or coagulating. If the adjusted antifreeze temperature is exceeded by 1 K [2 °Ra], the loading circuit will be deactivated.

If the antifreeze function is activated, ❄️ is displayed. If the antifreeze function is active, ⓪ and ❄️ are displayed (flashing).



Note:

Since this function uses the limited heat quantity of the store, the antifreeze function should only be used in regions with few days of temperatures around the freezing point.

The antifreeze function will be suppressed if the store temperature falls below +5 °C [+40 °F] in order to protect the store from frost damage.

Heat quantity measurement



OHQM

Heat quantity measurement
Adjustment range: OFF/ON
Factory setting: OFF



FMAX

Flow rate in l/min
Adjustment range: 0.5... 100.0
Factory setting: 6.0



MEDT

Heat transfer fluid
Adjustment range: 0... 3
Factory setting: 1



MED%

Antifreeze concentration
in Vol-% (MED% is not indicated when
MEDT 0 or 3 is used.)
Adjustment range: 20... 70%
Factory setting: 45%

If OHQM is activated, the heat quantity gained can be calculated and displayed. Heat quantity measurement is possible if a flowmeter is used.

The heat quantity balancing (estimation) uses the difference between the flow and return temperatures and the entered flow rate (at 100 % pump speed).

➔ Read the flow rate (l/min) and adjust it in the **FMAX** channel.

➔ Adjust the antifreeze type and concentration of the heat transfer fluid in the channels **MEDT** and **MED%**.

Heat transfer fluid:

0: Water

1: Propylene glycol

2: Ethylene glycol

3: Tyfocor® LS/G-LS

Drainback option



Note:

A drainback system requires additional components such as a holding tank. The drainback option should only be activated if all components required are properly installed.

In a drainback system the heat transfer fluid will flow into a holding tank if solar loading does not take place. The drainback option initiates the filling process if solar loading is about to start. If the drainback option is activated, the following adjustment can be made.

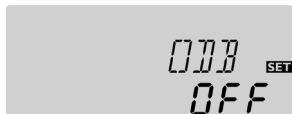

ODB

Drainback option

Adjustment range: OFF/ON

Factory setting: OFF



Note:

If the drainback option is activated, the cooling functions and the antifreeze function will not be available. If one or more than one of these functions have been activated before, they will be deactivated again as soon as **ODB** is activated. They will remain deactivated, even if **ODB** is deactivated later on.



Note:

If the drainback function **ODB** is activated, the factory settings of the parameters **nMN**, **DTO**, **DTF** and **DT S** will be adapted to values suiting drainback systems:

Additionally, the adjustment range and the factory setting of the collector emergency shutdown will change. Adjustments previously made in these channels will be overridden and have to be entered again if the drainback option is deactivated later on.

Time period – switch-on condition

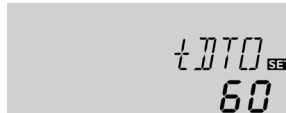

tDTO

Time period – switch-on condition

Adjustment range: 1 ... 100 s

Factory setting: 60 s

The parameter **tDTO** is used for adjusting the time period during which the switch-on condition must be permanently fulfilled.

Filling time



tFLL

Filling time

Adjustment range: 1.0 ... 30.0 min

Factory setting: 5.0 min

The filling time can be adjusted using the parameter **tFLL**. During this period, the pump runs at 100% speed.

Stabilisation

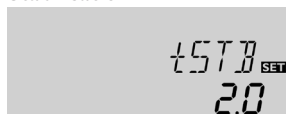

tSTB

Stabilisation

Adjustment range: 1.0 ... 15.0 min

Factory setting: 2.0 min

The parameter **tSTB** is used for adjusting the time period during which the switch-off condition will be ignored after the filling time has ended.

Operating mode

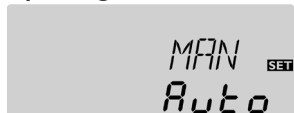

MAN

Operating mode

Adjustment range: OFF, Auto, ON

Factory setting: Auto

For control and service work, the operating mode of the relay can be manually adjusted. For this purpose, select the adjustment channel **MAN** in which the following adjustments can be made:

Operating mode

OFF : Relais off Δ (flashing) + ☞

Auto : Relay in automatic operation

ON : Relais on Δ (flashing) + ☞ + ⌚



Note:

Always adjust the operating mode back to **Auto** when the control and service work is completed. Normal operation is not possible in manual mode.

HE pump control



ADA1

HE pump control via adapter

Adjustment range: ON, OFF

Factory setting: OFF

This option is used for controlling a high-efficiency pump via a VBus®/PWM adapter. The power supply of the pump is carried out via the semiconductor relay (R1). For pump speed control with activated ADA1 option, the relay is switched on or off (no burst control). Temperature dependent speed information is transmitted via the VBus®. The relay will remain deactivated for 1 hour after its switch-off conditions have been fulfilled (pump protection).

Language



LANG

Language selection

Selection: dE, En, Fr

Factory setting: dE

In this adjustment channel the menu language can be selected.

- dE : German
- En : English
- Fr : French

Unit



UNIT

Temperature unit selection

Selection: °F, °C

Factory setting: °C

In this adjustment channel, the display unit for temperatures and temperature differences can be selected. The unit can be switched between °C/K and °F/°Ra during operation.

Temperatures and temperature differences in °F and °Ra are displayed without units. If the indication is set to °C, the units are displayed with the values.

Reset



RESE

Reset function

By means of the reset function, all adjustments can be set back to their factory settings.

→ In order to carry out a reset, press button 3

All adjustments that have previously been made will be lost! For this reason, a security enquiry will appear after the reset function has been selected.

Only confirm the security enquiry if you are sure you want to set back all adjustment to the factory setting.

Security enquiry

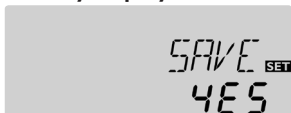

→ In order to confirm the security enquiry, press button 3.



Note:

After a reset, the commissioning menu will start again (see page 11).

7 Troubleshooting

If a malfunction occurs, the display symbols will indicate an error code.

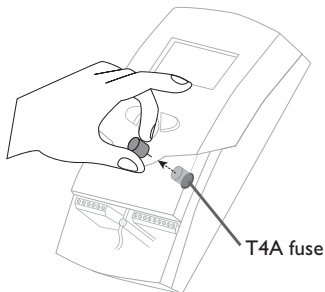

Operating control LED is permanently off.

Check the power supply of the controller. Is it disconnected?

no

The fuse of the controller could be blown. The fuse holder (which holds the spare fuse) becomes accessible when the cover is removed. The fuse can then be replaced.

yes

Check the supply line and reconnect it.

The symbol is indicated on the display and the symbol flashes.

Sensor fault. An error code instead of a temperature is shown on the sensor display channel.

888.8

Cable is broken. Check the cable.

- 88.8

Short circuit. Check the cable.

Disconnected Pt1000 temperature sensors can be checked with an ohmmeter. Please check the resistance values correspond with the table.

°C	°F	Ω	°C	°F	Ω
-10	14	961	55	131	1213
-5	23	980	60	140	1232
0	32	1000	65	149	1252
5	41	1019	70	158	1271
10	50	1039	75	167	1290
15	59	1058	80	176	1309
20	68	1078	85	185	1328
25	77	1097	90	194	1347
30	86	1117	95	203	1366
35	95	1136	100	212	1385
40	104	1155	105	221	1404
45	113	1175	110	230	1423
50	122	1194	115	239	1442

Resistance values of Pt1000 sensors



Note:

For answers to frequently asked questions (FAQ) see www.resol.com.

Pump is overheated, but no heat transfer from the collector to the store, flow and return have the same temperature; perhaps also bubbling in the lines.

Air or gas bubbles in the system?

no

yes

Are the valves or the non-return valves defective or is the dirt trap blocked?

yes

Vent the system; increase the system pressure to a static primary pressure of at least plus 0,5 bar [7.25 psi]; if necessary continue to increase the pressure; switch the pump on and off for a short time.

Clean the dirt trap or replace defective component

Pump starts up very late.

Switch-on temperature difference ΔT_{on} too large?

no

yes

Change ΔT_{on} and ΔT_{off} correspondingly.

Non-ideal position of the collector sensor (e. g. flatscrew sensor instead of sensor in immersion sleeves).

no

yes

Put the solar pump (R1) into the manual mode On for a short time during irradiation. Check whether the collector temperature significantly increases.

o.k.

Minimum limitation active

Pump starts for a short moment, switches off, switches on again, etc.

Temperature difference at the controller too small?

no

yes

Change ΔT_{on} and ΔT_{off} correspondingly.

Wrong position of collector sensors?

no

yes

Mount the collector sensor at solar flow (warmest collector output); use immersion sleeve of the respective collector.

Plausibility control of the option tube collector function

The temperature difference between store and collector increases enormously during operation; the collector circuit cannot dissipate the heat.

Collector circuit pump / zone valve defective?

no

yes

Check or replace, if necessary

Heat exchanger calcified?

no

yes

Decalcify it

Heat exchanger blocked?

no

yes

Clean it

Heat exchanger too small?

yes

Replace with correctly sized one.

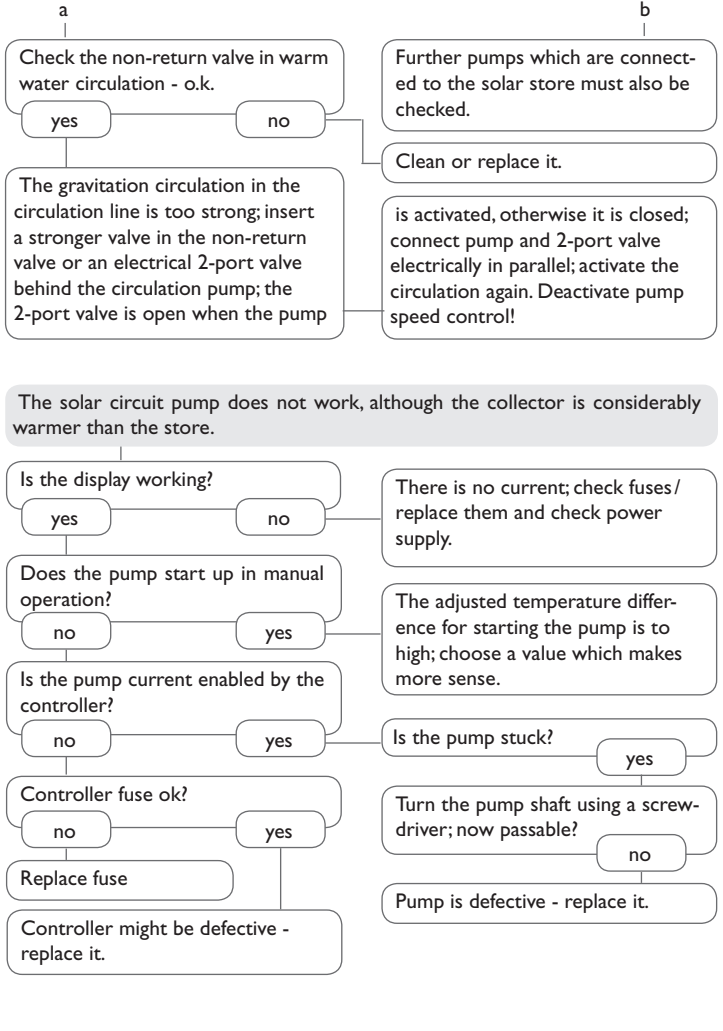
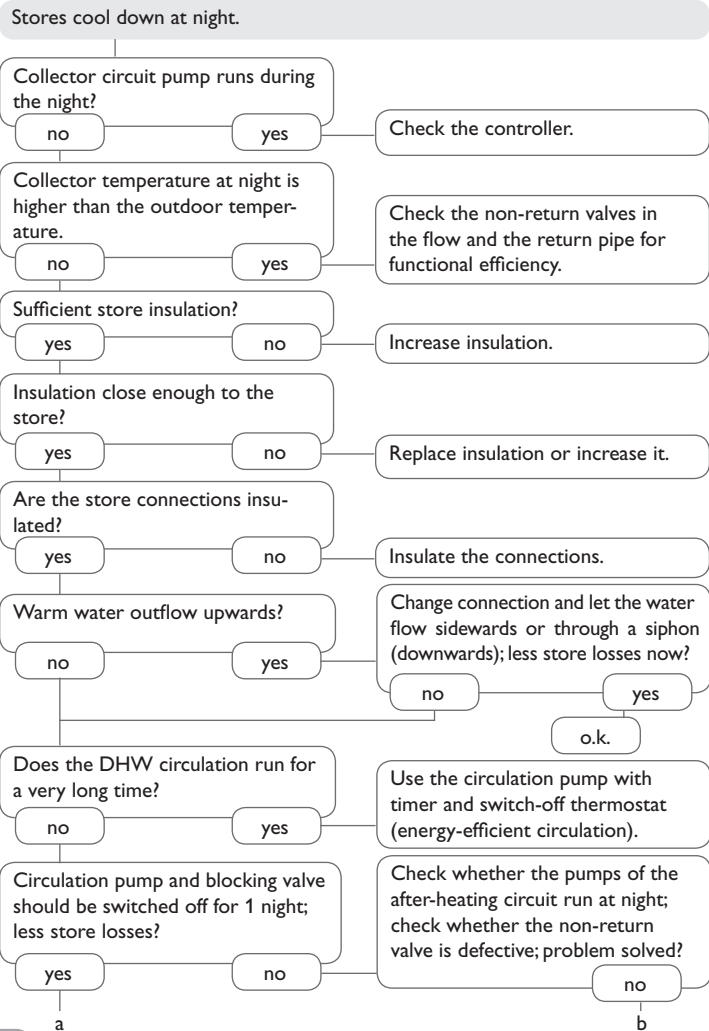



Sensors



Overvoltage protection device



SD3 Smart Display/
GA3 Large Display



AM1 Alarm Module



DL2 Datalogger



VBus®/USB & VBus®/LAN & VBus®/PWM
interface adapters

8.1 Sensors and measuring instruments

Sensors

The product range includes high-precision platinum temperature sensors, flatscrew sensors, outdoor temperature sensors, indoor temperature sensors, cylindrical clip-on sensors, also as complete sensors with immersion sleeve.

Overvoltage protection device

In order to avoid overvoltage damage at collector sensors (e.g. caused by local lightning storms), we recommend installing the RESOL SP10 Overvoltage protection.

8.2 VBus® accessories

SD3 Smart Display / GA3 Large Display

The RESOL SD3 Smart Display is designed for simple connection to RESOL controllers via the RESOL VBus®. It is used for visualising data issued by the controller: collector temperature, store temperature and energy yield of the solar thermal system. The use of high-efficiency LEDs and filter glass assures a high optical brilliance. An additional power supply is not required. One module is required per controller. The GA3 is a completely mounted large display module for visualisation of collector- and store temperatures as well as the heat quantity yield of the solar system via one 6-digit and two 4-digit 7-segment displays. An easy connection to all controllers with a RESOL VBus® is possible. The front plate is made of antireflective filterglass and is printed with a light-resistant UV-lacquering. The universal RESOL VBus® allows the parallel connection of 8 large displays as well as additional VBus® modules.

AM1 Alarm Module

The AM1 Alarm Module is designed to signal system failures. It is to be connected to the VBus® of the controller and issues an optical signal via the red LED if a failure has occurred. The AM1 also has a relay output, which can e. g. be connected to a building management system (BMS). Thus, a collective error message can be issued in the case of a system failure.

DL2 Datalogger

This additional module enables the acquisition and storage of large amounts of data (such as measuring and balance values of the solar system) over a long period of time. The DL2 can be configured and read-out with a standard Internet browser via its integrated web interface. For transmission of the data stored in the internal memory of the DL2 to a PC, an SD card can be used. The DL2 is appropriate for all controllers with RESOL VBus®. It can be connected directly to a PC or router for remote access and thus enables comfortable system monitoring for yield monitoring or for diagnostics of faults.

8.3 Interface adapters

VBus®/USB & VBus®/LAN & VBus®/PWM interface adapters

The VBus®/USB interface adapter is the interface between the controller and a personal computer. With its standard mini-USB port it enables a fast transmission of system data for processing, visualising and archiving data via the VBus®. The RESOL ServiceCenter software is included.

The VBus®/LAN interface adapter is designed for the direct connection of the controller to a PC or router. It enables easy access to the controller via the local network of the owner. Controller access and data charting can be effected from every workstation of the network by means of the RESOL ServiceCenter Software. The VBus®/LAN interface adapter is suitable for all controllers equipped with a RESOL VBus®. The RESOL ServiceCenter software is included.

The VBus®/PWM interface adapter enables the speed control of a high-efficiency pump via a PWM or 0-10 V signal. The adapter receives speed information of the controller via the VBus®. The speed will be transformed into a PWM or direct-current voltage signal and distributed to corresponding terminals.

A	
Accessories.....	25
Antifreeze function	18
C	
Code	22
Collector cooling	16
Collector emergency shutdown.....	16
Collector minimum limitation.....	18
Collector minimum temperature.....	18
Commissioning	11
Cooling functions	16
D	
ΔT control	14
Data communication / Bus	6
Displays.....	10
Drainback option	19
E	
Electrical connection	6
H	
Heat quantity measurement.....	18
HE pump	20
Holiday cooling option.....	17
L	
Language.....	20
M	
Manual mode.....	20
Minimum and maximum temperatures.....	18
Mounting.....	5
O	
Operating mode.....	20
S	
Sensor type.....	13
Speed control.....	15
Store cooling.....	17
System overview	10
T	
Technical data.....	4
Troubleshooting.....	22
U	
Unit.....	20

Distributed by:

RESOL – Elektronische Regelungen GmbH

Heiskampstraße 10
45527 Hattingen / Germany

Tel.: +49 (0) 23 24 / 96 48 - 0

Fax: +49 (0) 23 24 / 96 48 - 755

www.resol.com

info@resol.com

Important note

The texts and drawings in this manual are correct to the best of our knowledge. As faults can never be excluded, please note:

Your own calculations and plans, under consideration of the current standards and directions should only be basis for your projects. We do not offer a guarantee for the completeness of the drawings and texts of this manual - they only represent some examples. They can only be used at your own risk. No liability is assumed for incorrect, incomplete or false information and / or the resulting damages.

Note

The design and the specifications can be changed without notice.
The illustrations may differ from the original product.

Imprint

This mounting- and operation manual including all parts is copyrighted. Another use outside the copyright requires the approval of **RESOL – Elektronische Regelungen GmbH**. This especially applies for copies, translations, micro films and the storage into electronic systems.

© **RESOL – Elektronische Regelungen GmbH**