

DeltaSol[®] CS/2

Version 1.11

Solar controller
Manual for the
specialised craftsman
Installation
Operation
Functions and options
Troubleshooting



11204303

Thank you for buying this RESOL product.
Please read this manual carefully to get the best performance from this unit.
Please keep this manual carefully.

en

Manual
www.resol.com

Safety advice

Please pay attention to the following safety advice in order to avoid danger and damage to people and property.

Instructions

Attention must be paid to the valid local standards, regulations and directives!

Information about the product

Proper usage

The solar controller is designed for electronically controlling standard solar thermal systems in compliance with the technical data specified in this manual.

Improper use excludes all liability claims.

CE Declaration of conformity

The product complies with the relevant directives and is therefore labelled with the CE mark. The Declaration of Conformity is available upon request, please contact the manufacturer.



Note

Strong electromagnetic fields can impair the function of the controller.

- Make sure the controller as well as the system are not exposed to strong electromagnetic fields.

Subject to technical change. Errors excepted.

Target group

These instructions are exclusively addressed to authorised skilled personnel. Only qualified electricians are allowed to carry out electrical works. Initial commissioning must be effected by the system installer or qualified personnel named by the system installer.

Description of symbols

WARNING! Warnings are indicated with a warning triangle!



→ **They contain information on how to avoid the danger described.**

Signal words describe the danger that may occur, when it is not avoided.

- **WARNING** means that injury, possibly life-threatening injury, can occur
- **ATTENTION** means that damage to the appliance can occur



Note

Notes are indicated with an information symbol.

→ Arrows indicate instruction steps that should be carried out.

Disposal

- Dispose of the packaging in an environmentally sound manner.
- Dispose of old appliances in an environmentally sound manner. Upon request we will take back your old appliances bought from us and guarantee an environmentally sound disposal of the devices.

Solar controller *DeltaSol*® CS/2

The *DeltaSol*® CS/2 controller is used for the speed control of a HE pump in small standard solar thermal and heating systems.

It is equipped with a PWM output and an additional input for a VFD Grundfos Direct Sensor™ that enables a precise heat quantity measurement.

The commissioning menu will lead you through the most important adjustments for the initial configuration in only eight steps.

Contents

1	Overview	4	5	Commissioning	11
2	Installation	5	6	Channel overview	13
2.1	Mounting	5	6.1	Display channels.....	13
2.2	Electrical connection	5	6.2	Adjustment channels	15
2.3	VFD Grundfos Direct Sensor™	6	7	Troubleshooting	24
2.4	PWM output.....	6	8	Accessories	27
2.5	Data communication / Bus	6	8.1	Sensors and measuring instruments	28
2.6	Terminal allocation	7	8.2	VBus® accessories	28
3	Operation and function	9	8.3	Interface adapters.....	28
3.1	Buttons	9	9	Index	29
4	System-Monitoring-Display	9			
4.1	Flashing codes	10			

1 Overview

- Especially designed for the speed control of high-efficiency pumps
- 1 input for a VFD Grundfos Direct Sensor™
- System-Monitoring-Display
- Up to 4 Pt1000 temperature sensors
- Semiconductor relay for pump speed control
- HE pump control
- Heat quantity measurement
- Commissioning menu
- Function control
- Drainback option
- Unit °F and °C selectable

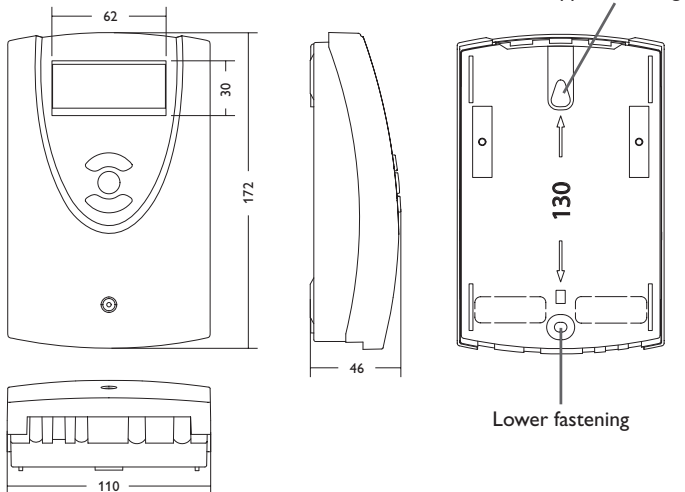

Technical data

Inputs: 4 Pt1000 temperature sensors, 1 VFD Grundfos Direct Sensor™

Outputs: 1 semiconductor relays, 1 PWM output

PWM frequency: 512 Hz

PWM voltage: 10.5 V

Switching capacity: 1 (1) A 240 V~ (semiconductor relay)

Total switching capacity: 1 A 240 V~

Power supply: 100 ... 240 V~ (50 ... 60 Hz)

Supply connection: type Y attachment

Standby: 0.58 W

Mode of operation: type 1.C.Y action

Rated impulse voltage: 2.5 kV

Data interface: RESOL VBus®

VBus® current supply: 35 mA

Functions: function control, operating hours counter, speed control, drainback option and heat quantity measurement

Housing: plastic, PC-ABS and PMMA

Mounting: wall mounting, mounting into patch panels is possible

Indication/Display: System-Monitoring-Display for visualisation of systems, 16-segment and 7-segment display, 8 symbols for indication of system status

Operation: 3 push buttons at the front

Ingress protection: IP 20 / EN 60529

Protection class: I

Ambient temperature: 0 ... 40 °C

Pollution degree: 2

Dimensions: 172 x 110 x 46 mm

2 Installation

2.1 Mounting

WARNING! Electric shock!



Upon opening the housing, live parts are exposed!
→ **Always disconnect the device from power supply before opening the housing!**



Note

Strong electromagnetic fields can impair the function of the controller.
→ Make sure the controller as well as the system are not exposed to strong electromagnetic fields.

The unit must only be located in dry interior rooms.

The controller must additionally be supplied from a double pole switch with contact gap of at least 3 mm.

Please pay attention to separate routing of sensor cables and mains cables.

In order to mount the device to the wall, carry out the following steps:

- Unscrew the crosshead screw from the cover and remove it along with the cover from the housing.
- Mark the upper fastening point on the wall. Drill and fasten the enclosed wall plug and screw leaving the head protruding.
- Hang the housing from the upper fastening point and mark the lower fastening point (centres 130 mm).
- Insert lower wall plug.
- Fasten the housing to the wall with the lower fastening screw and tighten.
- Carry out the electrical wiring in accordance with the terminal allocation (see chapter 2.2).
- Put the cover on the housing.
- Attach with the fastening screw.

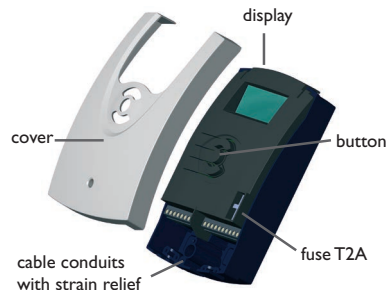

2.2 Electrical connection

WARNING! Electric shock!



Upon opening the housing, live parts are exposed!
→ **Always disconnect the device from power supply before opening the housing!**

ATTENTION! ESD damage!



Electrostatic discharge can lead to damage to electronic components!
→ **Take care to discharge properly before touching the inside of the device!**



Note

The mains connection must be carried out with the common ground of the building to which the pipework of the solar circuit is connected.



Note

Connecting the device to the power supply must always be the last step of the installation!



Note

The pump speed must be set to 100% when auxiliary relays or valves are connected.

**Note**

It must be possible to disconnect the device from the mains at any time.

- ➔ Install the mains plug such that it is accessible at any time.
- ➔ If this is not possible, install a switch that can be accessed.

Do not use the device if it is visibly damaged!

The power supply of the device must be 100 ... 240 V~ (50 ... 60 Hz). Attach flexible cables to the housing with the enclosed strain relief and the corresponding screws. The controller is equipped with 1 semiconductor relay to which **loads** such as pumps, valves, etc. can be connected:

Relay 1

18 = Conductor R1

17 = Neutral conductor N

13 = Protective earth conductor (⊕)

The **mains connection** is at the following terminals:

19 = Neutral conductor N

20 = Conductor L

12 = Protective earth conductor (⊕)

Connect the **temperature sensors** (S1 to S4) to the corresponding terminals with either polarity:

1/2 = Sensor 1 (e. g. collector sensor)

3/4 = Sensor 2 (e. g. store sensor)

5/6 = Sensor 3 (e. g. store sensor top)

7/8 = Sensor 4 (e. g. return sensor)

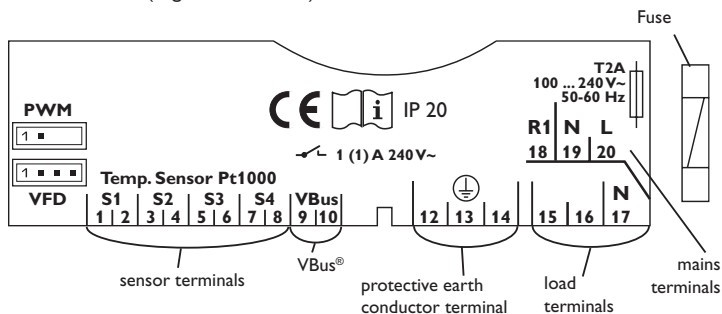
**2.3 VFD Grundfos Direct Sensor™**

The controller is equipped with 1 input for a digital VFD Grundfos Direct Sensor™ for measuring the flow rate and the temperature. Connection is made at the VFD terminal (bottom left).

2.4 PWM output

Speed control of a HE pump is possible via a PWM signal. The pump has to be connected to the relay as well as to the PWM output of the controller. Power is supplied to the HE pump by switching the corresponding relay on or off.

The two pins on the left-hand side of the connector marked **PWM** are the control output for a pump with PWM control input. The two pins on the right-hand side are not used.

PWM

1 = PWM output 1, control signal

2 = PWM output 1, GND

1 2

2.5 Data communication/Bus

The controller is equipped with the **RESOL VBus®** for data transfer and energy supply to external modules. The connection is to be carried out at the terminals marked **VBus** (either polarity).

One or more **RESOL VBus®** modules can be connected via this data bus, such as:

- RESOL DL2 Datalogger
- RESOL DL3 Datalogger

Furthermore, the controller can be connected to a PC or integrated into a network via the VBus®/USB or VBus®/LAN interface adapter (not included). Different solutions for visualisation and remote parameterisation are available on the RESOL website www.resol.com.

**Note**

More accessories on page 27.

2.6 Terminal allocation

The controller calculates the temperature difference between collector sensor S1 and store sensor S2. If the difference is larger than or identical to the adjusted switch-on temperature difference (DT O), the solar pump will be activated by relay 1, and the store will be loaded until the switch-off temperature difference (DT F) or the maximum store temperature (SMX) is reached.

Sensors S3 and S4 can optionally be connected. S3 can optionally be used as the reference sensor for the store emergency shutdown option (OSEM). If heat quantity measurement (OHQM) is activated, S4 and VFD are used as the flow and return sensors.

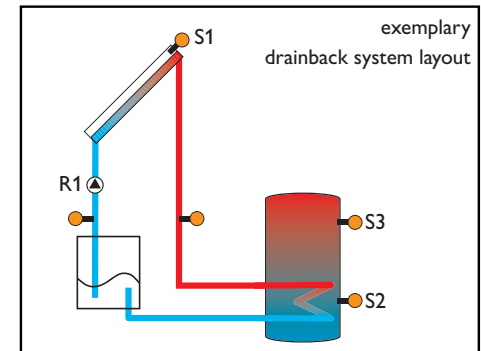
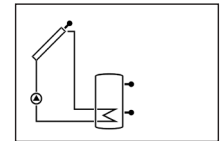
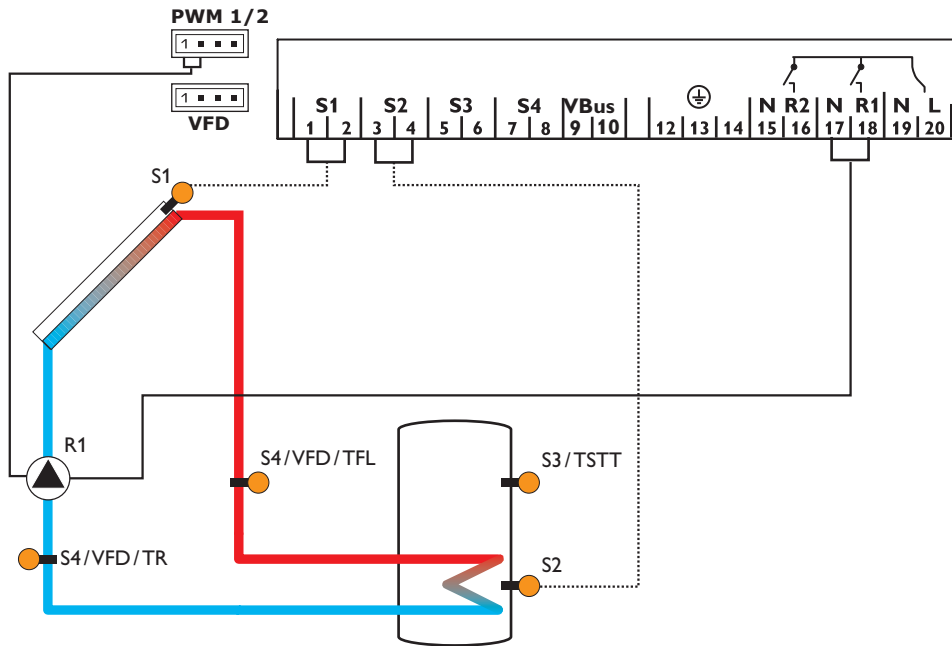

Display channels

Channel		Description	Connection terminal	Page
INIT	x*	ODB initialisation active	-	13
FLL	x*	ODB filling time active	-	13
STAB	x*	ODB stabilisation in progress	-	13
COL	x	Temperature collector	S1	13
TST	x	Temperature store	S2	13
S3	x	Temperature sensor 3	S3	14
TSTT	x*	Temperature store top	S3	13
S4	x	Temperature sensor 4	S4	14
TFL	x*	Temperature flow sensor	S1/S4/VFD	14
TR	x*	Temperature return sensor	S4/VFD	14
VFD	x*	Temperature Grundfos Direct Sensor™	VFD	14
L/h	x*	Flow rate Grundfos Direct Sensor™	VFD	14
n%	x	Speed	R1	14
hP	x	Operating hours	R1	15
kWh	x*	Heat quantity in kWh	-	14
MWh	x*	Heat quantity in MWh	-	14
TIME	x	Time	-	17

Adjustment channels

Channel		Description	Factory setting	Page
DT O	x	Switch-on temperature difference R1	6.0 K [12.0 °Ra]	15
DT F	x	Switch-off temperature difference R1	4.0 K [8.0 °Ra]	15
DT S	x	Set temperature difference R1	10.0 K [20.0 °Ra]	16
RIS	x	Rise R1	2 K [4 °Ra]	16
PUM	x	Pump control type R1	PSOL	16
nMN	x	Minimum speed R1	30%	16
nMX	x	Maximum speed R1	100%	17
S MX	x	Maximum store temperature	60 °C [140 °F]	17
OSEM	x	Store emergency shutdown option	OFF	17
EM	x	Collector emergency temperature	130 °C [270 °F]	17
		Collector emergency temperature if ODB is activated:	95 °C [200 °F]	17
OCC	x	Collector cooling option	OFF	18
CMX	x*	Maximum collector temperature	110 °C [230 °F]	18
OSYC	x	System cooling option	OFF	18

Adjustment channels

Channel		Description	Factory setting	Page
DTCO	x*	Switch-on temperature difference cooling	20.0 K [40.0 °Ra]	18
DTCF	x*	Switch-off temperature difference cooling	15.0 K [30.0 °Ra]	18
OSTC	x	Store cooling option	OFF	19
OHOL	x*	Holiday cooling option	OFF	19
THOL	x*	Holiday cooling temperature	40 °C [110 °F]	19
OCN	x	Collector minimum limitation option	OFF	19
CMN	x*	Collector minimum temperature	10 °C [50 °F]	19
OCF	x	Antifreeze option	OFF	19
CFR	x*	Antifreeze temperature	4.0 °C [40.0 °F]	19
GFD	x	Grundfos Direct Sensor™	OFF	20
OHQM	x	Heat quantity measurement option	OFF	20
SEN	x*	VFD allocation	2	21
FMAX	x*	Maximum flow rate	6.0 l/min	20
MEDT	x*	Antifreeze type	1	21
MED%	x*	Antifreeze concentration (only if MEDT = propylene or ethylene glycol)	45 %	21
ODB	x	Drainback option	OFF	21
tDTO	x*	ODB switch-on condition - time period	60 s	22
tFLL	x*	ODB filling time	5.0 min	22
tSTB	x*	ODB stabilisation time	2.0 min	22
MAN	x	Manual mode R1	Auto	22
LANG	x	Language	dE	22
UNIT	x	Temperature unit	°C	23
RESE	x	Reset - back to factory settings		23
#####		Version number		

Legend:

Symbol	Description
x	Channel is available
x*	Channel is available, if the corresponding option is activated.

3 Operation and function

3.1 Buttons

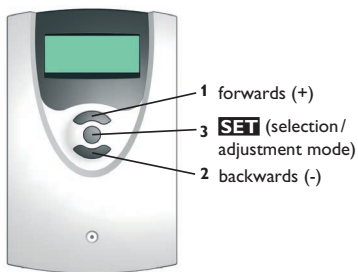

The controller is operated via the 3 push buttons below the display.

Button 1 (+) is used for scrolling forwards through the menu and increasing adjustment values. **Button 2 (-)** is used for scrolling backwards through the menu and reducing adjustment values. **Button 3 (OK)** is used for selecting channels and confirming adjustments.

During normal operation, display channels will be displayed.

→ In order to scroll between display channels, press buttons 1 and 2.

Access to adjustment channels:

→ Use button 1 in order to scroll to the last display channel, then press and hold down button 1 for approx. 2 s.

If an **adjustment channel** is shown on the screen, **SET** will be displayed on the right-hand side next to the channel name.

→ Press button 3 in order to select an adjustment channel.

SET starts flashing.

→ Adjust the desired value with buttons 1 and 2.

→ Briefly press button 3.

SET permanently appears, the adjusted value has been saved.

4 System-Monitoring-Display

System-Monitoring-Display



The System-Monitoring-Display consists of 3 blocks: channel display, tool bar and system screen.

Channel display

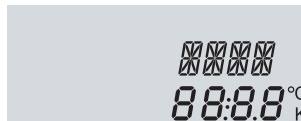

The channel display consists of 2 lines. The upper display line is an alphanumeric 16-segment display. In this line, mainly channel names and menu items are displayed. In the lower 16-segment display, values are displayed.

Tool bar

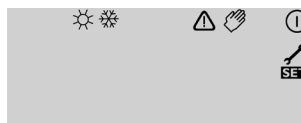

The additional symbols in the tool bar indicate the current system state.

Permanently shown	Flashing	Status indications:
ⓘ		Relay 1 active
☀		Maximum store temperature exceeded
	⚠ + ☀	Store emergency shutdown active
	⚠	Collector emergency shutdown active
ⓘ	☀	Collector cooling active
ⓘ	☀	System cooling active
ⓘ + ☀		Store cooling active
☀	⚠	Holiday cooling option activated
ⓘ + ☀	⚠	Holiday cooling active
	☀	Collector minimum limitation active
☀		Antifreeze function activated
ⓘ	☀	Antifreeze function active
👤 + ⓘ	⚠	Manual mode relay 1 ON
👤	⚠	Manual mode relay 1 OFF
🔧	⚠	Sensor fault

4.1 Flashing codes

- Pump is flashing when the relay is switched on
- Sensor symbols are flashing, if the corresponding sensor display channel is selected
- Sensors are flashing quickly in the case of a sensor fault

System screen

The system selected is indicated in the System-Monitoring-Display. It consists of several system component symbols which are – depending on the current status of the system – either flashing, permanently shown or not indicated.

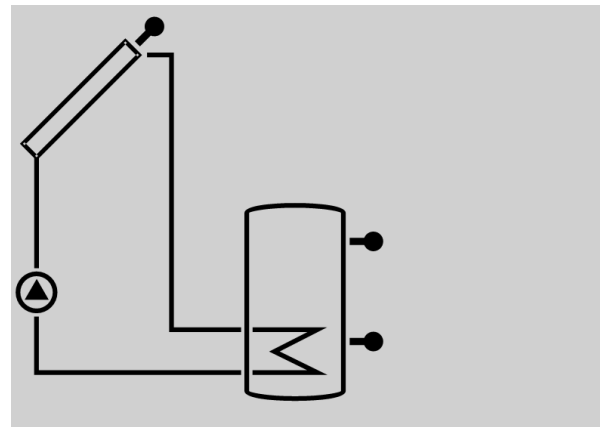

Collector
with collector sensor



Temperature sensor



Store
with heat exchanger



Pump

5 Commissioning

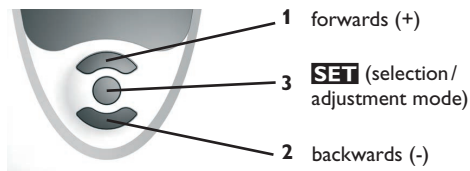

→ Connect the device to the mains

The controller runs an initialisation phase.

When the controller is commissioned or when it is reset, it will run a commissioning menu. The commissioning menu leads the user through the most important adjustment channels needed for operating the system.

Operation

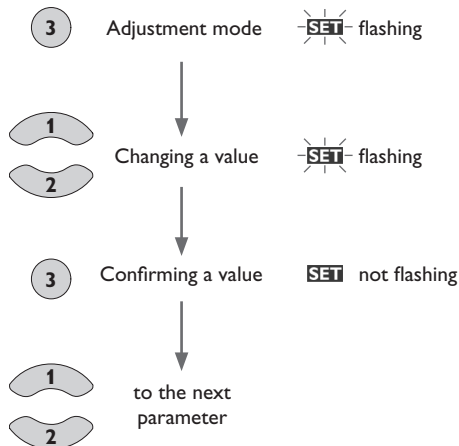

Commissioning

1. Language

→ Adjust the desired menu language.

LANG

Language selection

Selection: dE, En, Fr, ES, It

Factory setting: dE

2. Temperature unit

→ Adjust the desired unit.

UNIT

Temperature unit

Selection: °F, °C

Factory setting: °C

3. Maximum store temperature

→ Adjust the desired maximum store temperature.

SMX

Maximum store temperature

Adjustment range: 4 ... 95 °C [40 ... 200 °F]

Factory setting: 60 °C [140 °F]



Note

The controller is also equipped with a non-adjustable emergency shutdown, deactivating the system if the store reaches 95 °C [200 °F].

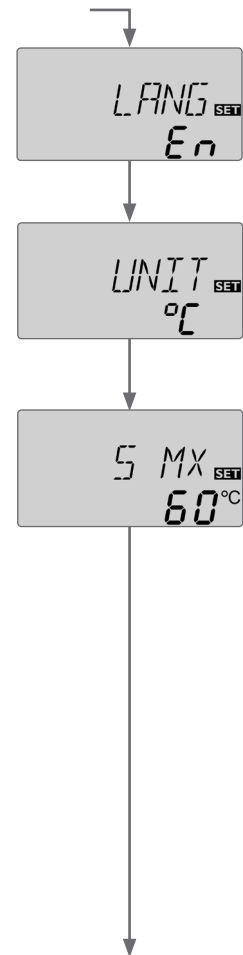

Commissioning

6. Pump control type

→ Adjust the pump control type.

PUM

Pump control type

Selection: OnOF, PULS, PSOL, PHEA

Factory setting: PSOL

The following types can be selected:

Adjustment for standard pump without speed control

- OnOF (pump on / pump off)

Adjustment for standard pump with speed control

- PULS (burst control via semiconductor relay)

Adjustment for high-efficiency pump (HE pump)

- PSOL (PWM profile for a HE solar pump)

- PHEA (PWM profile for a HE heating pump)

7. Minimum speed

→ Adjust the minimum speed for the corresponding pump.

nMN

Minimum speed

Adjustment range: (10) 30... 100%

Factory setting: 30%



Note

The pump speed must be set to 100% when auxiliary relays or valves are connected.

Commissioning

8. Maximum speed

→ Adjust the maximum speed for the corresponding pump.

nMX

Maximum speed

Adjustment range: (10) 30... 100%

Factory setting: 100%



Note

The pump speed must be set to 100% when auxiliary relays or valves are connected.

Confirmation

Completing the commissioning menu

After the last channel of the commissioning menu has been adjusted and confirmed, the controller asks for confirmation of the adjustments.

→ In order to confirm the adjustments made in the commissioning menu, press button 3.

The controller is then ready for operation with the adjustments made for the system selected.



Note

The adjustments carried out during commissioning can be changed anytime in the corresponding adjustment channel. Additional functions and options can also be activated or deactivated (see page 15).

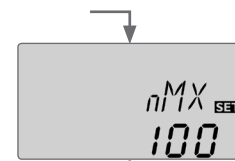
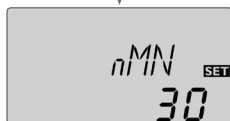
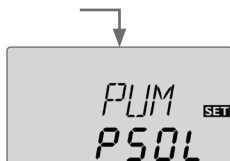

6 Channel overview

6.1 Display channels



Note

The display and adjustment channels as well as the adjustment ranges depend on the system selected, the functions and options as well as on the system components connected to the controller.

Display of drainback time periods

Initialisation

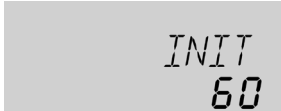

INIT

ODB initialisation active

Indicates the time adjusted in tDTO, running backwards.

Filling time



FLL

ODB filling time active

Indicates the time adjusted in tFLL, running backwards.

Stabilisation



STAB

ODB stabilisation in progress

Indicates the time adjusted in tSTB, running backwards.

Display of collector temperatures



COL

Collector temperature

Display range: -40 ... +260 °C [-40 ... +500 °F]

Indicates the collector temperatures.

Display of store temperatures



TST,TSTT

Store temperatures

Display range: -40 ... +260 °C [-40 ... +500 °F]

Indicates the store temperatures.

- TST : Store temperature (1-store system)
- TSTT : Store temperature top

Display of sensors 3, 4 and VFD



S3, S4, VFD

Sensor temperatures

Display range: -40... +260 °C [-40... +500 °F]

VFD: 0... 100%

Indicates the current temperature at the corresponding additional sensor (without control function).

- S3 : Temperature at sensor 3
- S4 : Temperature at sensor 4
- VFD : Grundfos Direct Sensor™



Note

S3 and S4 will only be indicated if the temperature sensors are connected to the corresponding terminals. VFD will be indicated only if a Grundfos Direct Sensor™ has been connected and registered.

Display of further temperatures



TFL, TR

Further measured temperatures

Display range: -40... +260 °C [-40... +500 °F]

Indicates the current temperature at the corresponding sensor. The display of these temperatures depends on the system selected.

- TFL : Temperature flow
- TR : Temperature return



Note

TFL/ TR will be indicated only if the heat quantity measurement option (OHQM) has been activated.

Display of flow rate

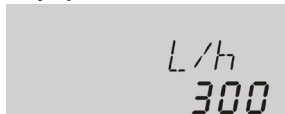

l/h

Flow rate

Display range: depending on the sensor type used

Indicates the current flow rate at the VFD flow rate sensor.

The display range depends on the sensor type previously selected.

Display of current pump speed

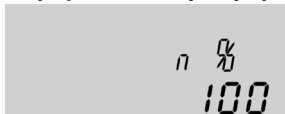

n %

Current pump speed

Display range: 30... 100%

Indicates the current pump speed.



kWh/MWh

Heat quantity in kWh/MWh

Display channel

Indicates the energy gained in heat quantity – only available if heat quantity measurement (OHQM) is activated.

The heat quantity measurement can be carried out in 2 different ways (see page 20): with a fixed flow rate value or with a VFD Grundfos Direct Sensor™. It is shown in kWh in the channel **kWh** and in MWh in the channel **MWh**. The overall heat quantity results from the sum of both values.

The accumulated heat quantity can be set back to zero. As soon as one of the display channels of the heat quantity is selected, the symbol **SET** is displayed.

➔ In order to access the reset mode of the counter, press button 3 for approx. 2 s.

SET starts flashing and the heat quantity value will be set back to zero.

→ In order to finish the reset process, press button 3.

In order to interrupt the reset process, do not press any button for about 5 s. The display returns to the display mode.

Operating hours counter

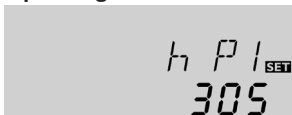

h P

Operating hours counter

Display channel

The operating hours counter accumulates the operating hours of the corresponding relay (**h P**). Full hours are displayed.

The accumulated operating hours can be set back to zero. As soon as an operating hours channel is selected, the symbol **SET** is displayed.

→ In order to access the reset mode of the counter, press button 3 for approx. 2 s.

SET starts flashing and the operating hours will be set back to zero.

→ In order to finish the reset process, press button 3.

In order to interrupt the reset process, do not press any button for about 5 s. The display returns to the display mode.

6.2 Adjustment channels

ΔT control

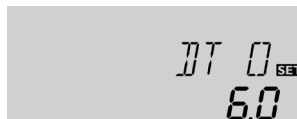

DT O

Switch-on temperature difference

Adjustment range: 1.0 ... 20.0 K [2.0 ... 40.0 °Ra]

Factory setting: 6.0 K [12.0 °Ra]

The controller works as a standard differential controller. If the temperature reaches or exceeds the switch-on temperature difference, the pump switches on.

When the temperature difference reaches or falls below the adjusted switch-off temperature difference, the respective relay switches off.



Note

The switch-on temperature difference must be at least 0.5 K [1 °Ra] higher than the switch-off temperature difference.



DT F

Switch-off temperature difference

Adjustment range: 0.5 ... 19.5 K [1.0 ... 39.0 °Ra]

Factory setting: 4.0 K [8.0 °Ra]



Note

If the drainback option **ODB** is activated, the values of the parameters **DT O**, **DT F** and **DTS** will be adapted to values suiting drainback systems:

DT O = 10 K [20 °Ra]

DT F = 4 K [8 °Ra]

DTS = 15 K [30 °Ra]

Adjustments that have been previously made in these channels will be overridden and have to be entered again if **ODB** is deactivated later on.

Speed control

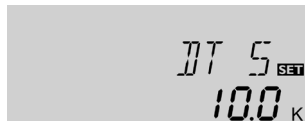

DTS

Set temperature difference

Adjustment range:

1.5 ... 30.0 K [3.0 ... 60.0 °Ra]

Factory setting: 10.0 K [20.0 °Ra]



Note

For pump speed control, the operating mode of the corresponding relay must be set to Auto (adjustment channel **MAN**).

If the temperature difference reaches or exceeds the switch-on temperature difference, the pump switches on at 100% speed for 10 s. Then, the speed is reduced to the minimum pump speed value.

If the temperature difference reaches the adjusted set value, the pump speed increases by one step (10%). The response of the controller can be adapted via the parameter Rise. Each time the difference increases by the adjustable rise value, the pump speed increases by 10% until the maximum pump speed of 100% is reached. If the temperature difference decreases by the adjustable rise value, pump speed will be decreased by one step.



Note

The set temperature difference must be at least 0.5 K [1 °Ra] higher than the switch-on temperature difference.



PUM

Pump control type

Selection: OnOF, PULS, PSOL, PHEA

Factory setting: PSOL



RIS

Rise

Adjustment range:

1 ... 20 K [2 ... 40 °Ra]

Factory setting: 2 K [4 °Ra]

With this parameter, the pump control type can be adjusted. The following types can be selected:

Adjustment for standard pump without speed control

- OnOF (pump on/pump off)

Adjustment for standard pump with speed control

- PULS (burst control via semiconductor relay)

Adjustment for high-efficiency pump (HE pump)

- PSOL (PWM profile for a HE solar pump)
- PHEA (PWM profile for a HE heating pump)

Minimum speed

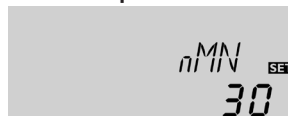

nMN

Minimum speed

Adjustment range: (10) 30 ... 100%

Factory setting: 30%

nMN, n1MN, if ODB is activated: 50%

In the adjustment channel **nMN**, a relative minimum pump speed for a pump connected can be allocated to the output R1.



Note

The pump speed must be set to 100% when auxiliary relays or valves are connected.



nMX

Maximum speed

Adjustment range: (10) 30 ... 100 %

Factory setting: 100 %

In the adjustment channel **nMX**, a relative maximum speed for a pump connected can be allocated to the output R1.



Note

The pump speed must be set to 100% when auxiliary relays or valves are connected.

Maximum store temperature

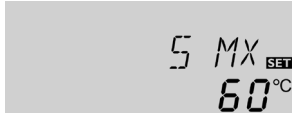

SMX

Maximum store temperature

Adjustment range: 4 ... 95 °C [40 ... 200 °F]

Arr 10: 4 ... 90 °C [40 ... 190 °F]

Factory setting: 60 °C [140 °F]

If the store temperature reaches the adjusted maximum temperature, the store will no longer be loaded in order to avoid damage caused by overheating. A non-adjustable hysteresis of 2 K [4 °Ra] is set for the maximum store temperature.

If the maximum store temperature is exceeded, ✱ is displayed.



Note

If the collector cooling or the system cooling function is activated, the adjusted maximum store temperature may be exceeded. In order to prevent system damage, the controller is also equipped with an integrated store emergency shutdown, deactivating the system if the store reaches 95 °C [200 °F].

Store emergency shutdown

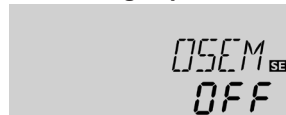

OSEM

Store emergency shutdown option

Adjustment range: ON, OFF

Factory setting: OFF

This option is used for activating the internal store emergency shutdown for an upper store sensor. If the temperature at the reference sensor exceeds 95 °C, store 1 will be blocked and loading will be stopped until the temperature falls below 90 °C.



Note

Sensor S3 ist used as the reference sensor.

Collector limit temperature

Collector emergency shutdown

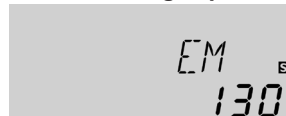

EM

Collector limit temperature

Adjustment range: 80 ... 200 °C [170 ... 390 °F]

Factory setting: 130 °C [270 °F]

When the collector temperature exceeds the adjusted collector limit temperature, the solar pump (R1) switches off in order to protect the system components against overheating (collector emergency shutdown). If the collector limit temperature is exceeded, Δ is displayed.



Note

If the drainback option **ODB** is activated, the adjustment range of **EM** will change to 80 ... 120 °C [170 ... 250 °F]. The factory setting in that case is 95 °C [200 °F].

Cooling functions

In the following the 3 cooling functions – collector cooling, system cooling and store cooling – are described in detail. The following note is valid for all three cooling functions:



Note

The cooling functions will not become active as long as solar loading is possible.

Collector cooling



OCC

Collector cooling option

Adjustment range: OFF/ON

Factory setting: OFF



CMX

Collector maximum temperature

Adjustment range: 70... 160 °C [150... 320 °F]

Factory setting: 110 °C [230 °F]

The collector cooling function keeps the collector temperature within the operating range by heating the store. If the store temperature reaches 95 °C [200 °F] the function will switch off for safety reasons.

If the store temperature exceeds the adjusted maximum store temperature, the solar system is switched off. If the collector temperature increases to the adjusted maximum collector temperature, the solar pump is activated until the collector temperature falls below the maximum collector temperature. The store temperature may then exceed the maximum store temperature, but only up to 95 °C [200 °F] (emergency shutdown of the store).

If the collector cooling function is active, and are displayed (flashing).



Note

This function will only be available if the system cooling function (**OSYC**) is deactivated.

System cooling

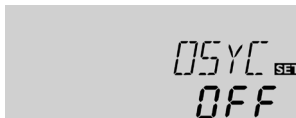

OSYC

System cooling option

Adjustment range: OFF/ON

Factory setting: OFF



DTCD

Switch-on temperature difference

Adjustment range:

1.0... 30.0 K [2.0... 60.0 °Ra]

Factory setting: 20.0 K [40.0 °Ra]

The system cooling function aims to keep the solar system operational for a longer time. The function overrides the maximum store temperature to provide thermal relief of the collector field and the heat transfer fluid on hot days. If the store temperature is higher than the adjusted maximum store temperature and the switch-on temperature difference **DTCD** is reached, the solar pump remains switched on or will be switched on. Solar loading is continued until either the temperature difference falls below the adjusted value **DTCF** or the collector limit temperature is reached. If the system cooling function is active, and are displayed (flashing).



DTCF

Switch-off temperature difference

Adjustment range: 0.5... 29.5 K [1.0... 59.0 °Ra]

Factory setting: 15.0 K [30.0 °Ra]



Note

This function will only be available, if the collector cooling function (**OCC**) is deactivated.

Store cooling



OSTC

Store cooling option

Adjustment range: OFF/ON

Factory setting: OFF

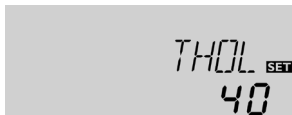

THOL

Holiday cooling temperature

Adjustment range: 20 ... 80 °C [70 ... 175 °F]

Factory setting: 40 °C [110 °F]

When the store cooling function is activated, the controller aims to cool down the store during the night in order to prepare it for solar loading on the following day. If the adjusted maximum store temperature (**SMX**) is exceeded and the collector temperature falls below the store temperature, the system will be reactivated in order to cool down the store. Cooling will continue until the store temperature has fallen below the adjusted maximum store temperature (**SMX**) again. A hysteresis of 2 K [4 °Ra] is set for the store cooling function.

Reference threshold temperature differences for the store cooling function are **DTO** and **DTF**.

If no DHW consumption is expected for a longer period of time, the additional holiday cooling option **OHOL** can be activated in order to extend the store cooling function. The adjustable temperature **THOL** then replaces the maximum store temperature (**SMX**) as the switch-off temperature for the store cooling function. When the holiday cooling function is activated, ☼ and △ (flashing) are shown on the display.

If the holiday cooling function is active, ☉, ☼ and △ are displayed (flashing).



OHOL

Holiday cooling option

Adjustment range: OFF/ON

Factory setting: OFF

Collector minimum limitation



OCN

Collector minimum limitation option

Adjustment range: OFF/ON

Factory setting: OFF



CMN

Minimum collector temperature

Adjustment range:

10.0 ... 90.0 °C [50.0 ... 190.0 °F]

Factory setting: 10.0 °C [50.0 °F]

If the collector minimum limitation option is activated, the pump (R1/R2) will only be switched on, if the adjustable collector minimum temperature is exceeded. The minimum temperature prevents the pump from being switched on too often at low collector temperatures. A hysteresis of 5 K [10 °Ra] is set for this function. If the collector minimum limitation is active, ☼ is displayed (flashing).



Note

If **OSTC** or **OCF** is active, the collector minimum limitation will be overridden. In that case, the collector temperature may fall below **CMN**.

Antifreeze function



OCF

Antifreeze function option

Adjustment range: OFF/ON

Factory setting: OFF



CFR

Antifreeze temperature

Adjustment range:

-40.0 ... +10.0 °C [-40.0 ... +50.0 °F]

Factory setting: +4.0 °C [+40.0 °F]

The antifreeze function activates the loading circuit between the collector and the store when the temperature falls below the adjusted antifreeze temperature. This will protect the fluid against freezing or coagulating. If the adjusted antifreeze temperature is exceeded by 1 K [2 °Ra], the loading circuit will be deactivated. If the antifreeze function is activated, ☼ is displayed. If the antifreeze function is active, ☉ and ☼ are displayed (flashing).



Note

Since this function uses the limited heat quantity of the store, the anti-freeze function should only be used in regions with few days of temperatures around the freezing point.

The antifreeze function will be suppressed if the store temperature falls below +5 °C [+40 °F] in order to protect the store from frost damage.

Grundfos Direct Sensor™ registration



GFD

Grundfos Direct Sensor™ registration

Selection: OFF, 12, 40, 40F

Factory setting: OFF

Registration of a digital flow rate sensor which can be used for heat quantity measurement.

OFF : no Grundfos Direct Sensor™

12 : VFD 1-12 (water/propylene glycol mixture)

40 : VFD 2-40

40F : VFD 2-40 Fast (water only)

Heat quantity measurement

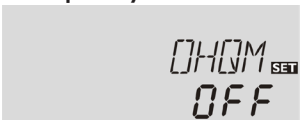

OHQM

Heat quantity measurement option

Adjustment range: OFF/ON

Factory setting: OFF

If **OHQM** is activated, the heat quantity gained can be calculated and displayed.

The heat quantity measurement can be carried out in 2 different ways (see below): with a fixed flow rate value or with a VFD Grundfos Direct Sensor™.

Heat quantity measurement with fixed flow rate value

The heat quantity balancing (estimation) uses the difference between the flow and return temperatures and the entered flow rate (at 100% pump speed).

- ➔ Read the flow rate (l/min) and adjust it in the **FMAX** channel.
- ➔ Adjust the antifreeze type and concentration of the heat transfer fluid in the channels **MEDT** and **MED%**.



FMAX

Flow rate in l/min

Adjustment range: 0.5 ... 100.0

Factory setting: 6.0



Note:

The FMAX channel will be available only if the SEN channel has been set to OFF or if no VFD Grundfos Direct Sensor™ is activated.

Heat quantity measurement with a VFD Grundfos Direct Sensor™

Heat quantity measurement with a VFD Grundfos Direct Sensor™ is possible in all system layouts.

In order to use a VFD Grundfos Direct Sensor™ for heat quantity measurement, proceed as follows:

- ➔ Register the VFD Grundfos Direct Sensor™ in the **GFD** channel.
- ➔ Adjust the position of the **VFD** Grundfos Direct Sensor™ in the **SEN** channel.
- ➔ Adjust the type and concentration of the heat transfer fluid in the channels **MEDT** and **MED%**.



SEN

Digital flow rate sensor (only if SEN = 12, 40 or 40F)

Selection: OFF, 1, 2

Factory setting: 2

Flow rate detection type:

OFF : fixed flow rate value (flowmeter)

1 : Grundfos Direct Sensor™ in the flow pipe

2 : Grundfos Direct Sensor™ in the return pipe

Sensor allocation for heat quantity measurement:

SEN = 1		SEN = 2		SEN = OFF	
SFL	SRET	SFL	SRET	SFL	SRET
GFD	S4	S4	GFD	S1	S4



MEDT

Heat transfer fluid

Adjustment range: 0 ... 3

Factory setting: 1

Heat transfer fluid:

0 : Water

1 : Propylene glycol

2 : Ethylene glycol

3 : Tyfocor® LS/G-LS



MED%

Antifreeze concentration

in Vol-% (MED% is not indicated when MEDT 0 or 3 is used.)

Adjustment range: 20 ... 70%

Factory setting: 45%

Drainback option



Note

A drainback system requires additional components such as a holding tank. The drainback option should only be activated if all components required are properly installed.

In a drainback system the heat transfer fluid will flow into a holding tank if solar loading does not take place. The drainback option initiates the filling process if solar loading is about to start. If the drainback option is activated, the following adjustment can be made.

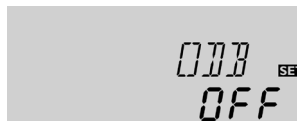

ODB

Drainback option

Adjustment range: OFF/ON

Factory setting: OFF



Note

If the drainback option is activated, the cooling functions and the antifreeze function will not be available. If one or more than one of these functions have been activated before, they will be deactivated again as soon as **ODB** is activated. They will remain deactivated, even if **ODB** is deactivated later on.



Note

If the drainback option **ODB** is activated, the factory settings of the parameters **nMN**, **DTO**, **DTF** and **DTS** will be adapted to values suiting drainback systems:

Additionally, the adjustment range and the factory setting of the collector emergency shutdown will change. Adjustments previously made in these channels will be overridden and have to be entered again if the drainback option is deactivated later on.

Time period – switch-on condition

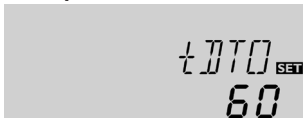

tDTP

Time period – switch-on condition

Adjustment range: 1 ... 100 s

Factory setting: 60 s

The parameter **tDTP** is used for adjusting the time period during which the switch-on condition must be permanently fulfilled.

Filling time



tFLL

Filling time

Adjustment range: 1.0 ... 30.0 min

Factory setting: 5.0 min

The parameter **tFLL** is used for adjusting the filling time. During this period, the pump runs at 100% speed.

Stabilisation

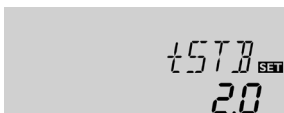

tSTB

Stabilisation

Adjustment range: 1.0 ... 15.0 min

Factory setting: 2.0 min

The parameter **tSTB** is used for adjusting the time period during which the switch-off condition will be ignored after the filling time has ended.

Operating mode

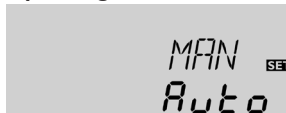

MAN

Operating mode

Adjustment range: OFF, Auto, On

Factory setting: Auto

For control and service work, the operating mode of the relays can be manually adjusted. For this purpose, select the adjustment value **MAN** in which the following adjustments can be made:

• MAN

Operating mode

OFF : Relay off Δ (flashing) + ☞

Auto : Relay in automatic operation

ON : Relay on Δ (flashing) + ☞ + ⓘ / Ⓜ



Note

Always adjust the operating mode back to **Auto** when the control and service work is completed. Normal operation is not possible in manual mode.

Language



LANG

Language selection

Selection: dE, En, Fr, ES, It

Factory setting: dE

In this adjustment channel the menu language can be selected.

- dE : German
- En : English
- Fr : French
- ES : Spanish
- It : Italian

Unit



UNIT

Temperature unit selection

Selection: °F, °C

Factory setting: °C

In this adjustment channel, the display unit for temperatures and temperature differences can be selected. The unit can be switched between °C/K and °F/°Ra during operation.

Temperatures and temperature differences in °F and °Ra are displayed without units. If the indication is set to °C, the units are displayed with the values.

Reset



RESE

Reset function

By means of the reset function, all adjustments can be set back to their factory settings.

→ In order to carry out a reset, press button 3

All adjustments that have previously been made will be lost! For this reason, a security enquiry will appear after the reset function has been selected.

Only confirm the security enquiry if you are sure you want to set back all adjustment to the factory setting.

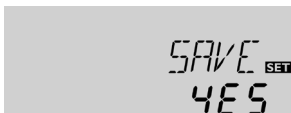

Security enquiry

→ In order to confirm the security enquiry, press button 3





Note

After a reset, the commissioning menu will start again (see page 11).

7 Troubleshooting

If a malfunction occurs, the display symbols will indicate an error code:

The symbol  is indicated on the display and the symbol  is flashing.

Sensor fault. An error code instead of a temperature is shown on the sensor display channel.

888.8

- 88.8

Cable is broken. Check the cable.

Short circuit. Check the cable.

Disconnected Pt1000 temperature sensors can be checked with an ohmmeter. Please check the resistance values correspond with the table.

°C	°F	Ω	°C	°F	Ω
-10	14	961	55	131	1213
-5	23	980	60	140	1232
0	32	1000	65	149	1252
5	41	1019	70	158	1271
10	50	1039	75	167	1290
15	59	1058	80	176	1309
20	68	1078	85	185	1328
25	77	1097	90	194	1347
30	86	1117	95	203	1366
35	95	1136	100	212	1385
40	104	1155	105	221	1404
45	113	1175	110	230	1423
50	122	1194	115	239	1442

Resistance values of Pt1000 sensors

The display is permanently off.

If the display is off, check the power supply of the controller. Is it disconnected?

no

yes

The fuse of the controller could be blown. The fuse holder (which holds the spare fuse) becomes accessible when the cover is removed. The fuse can then be replaced.

Check the supply line and reconnect it.

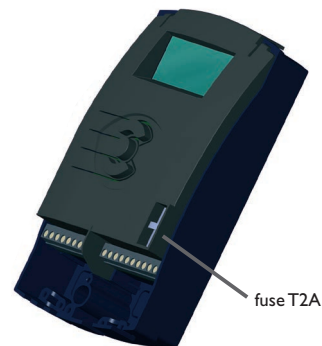

Pump is overheated, but no heat transfer from the collector to the store, flow and return have the same temperature; perhaps also bubbling in the lines.

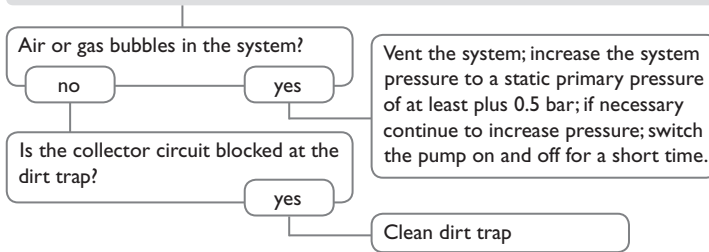

Pump starts up very late.

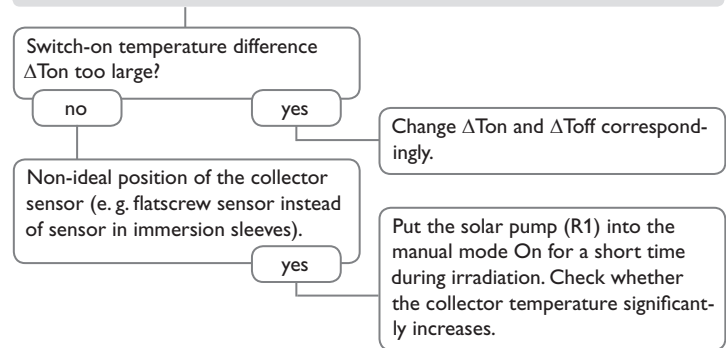

Pump starts for a short moment, switches off, switches on again, etc.

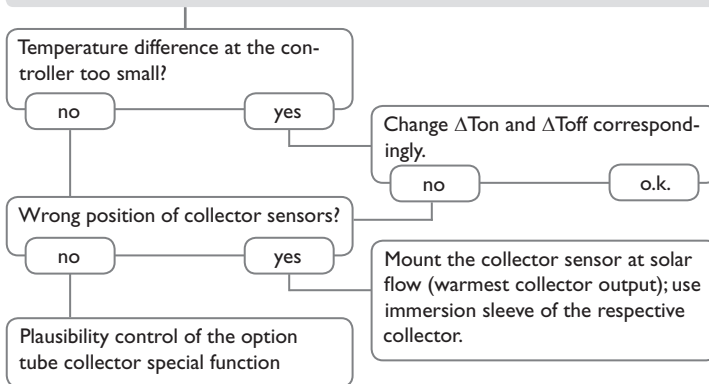

The temperature difference between store and collector increases enormously during operation; the collector circuit cannot dissipate the heat.

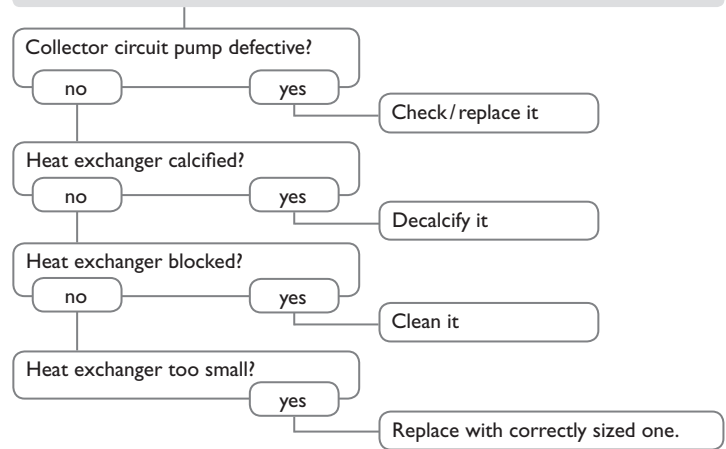

Note:

For answers to frequently asked questions (FAQ) see www.resol.com.

Store cool down at night

Collector circuit pump runs during the night?

no

yes

Check controller

Collector temperature at night is higher than the outdoor temperature.

no

yes

Check the non-return valves in the flow and the return pipe for functional efficiency.

Sufficient store insulation?

yes

no

Increase insulation.

Insulation close enough to the store?

yes

no

Replace insulation or increase it.

Are the store connections insulated?

yes

no

Insulate the connections.

Warm water outflow upwards?

no

yes

Change connection and let the water flow sideways or through a siphon (downwards); less store losses now?

no

o.k.

yes

Does the DHW circulation run for a very long time?

no

yes

Use the circulation pump with timer and switch-off thermostat (energy-efficient circulation).

Circulation pump and blocking valve should be switched off for 1 night; less store losses?

yes

no

Check whether the pumps of the after-heating circuit run at night; check whether the non-return valve is defective; problem solved?

no

a

b

a

Check the non-return valve in warm water circulation - o.k.

yes

no

The gravitation circulation in the circulation line is too strong; insert a stronger valve in the non-return valve or an electrical 2-port valve behind the circulation pump; the 2-port valve is open when the pump is activated,

b

Further pumps which are connected to the solar store must also be checked.

Clean or replace it.

otherwise it is closed; connect pump and 2-port valve electrically in parallel; activate the circulation again. Deactivate pump speed control!

The solar circuit pump does not work, although the collector is considerably warmer than the store

Is the display working?

yes

no

There is no current; check fuses / replace them and check power supply.

Does the pump start up in manual operation?

no

yes

The adjusted temperature difference for starting the pump is too high; choose a value which makes more sense.

Is the pump current enabled by the controller?

no

yes

Is the pump stuck?

yes

Controller fuse ok?

no

yes

Turn the pump shaft using a screwdriver; now passable?

no

Replace fuse

Controller might be defective - replace it.

Pump is defective - replace it.



Sensors



SP10 Overvoltage protection device



VFD Grundfos Direct Sensor™



VBus®/USB & VBus®/LAN interface adapters



SD3 Smart Display / GA3 Large Display



AM1 Alarm Module



DL2 Datalogger



DL3 Datalogger

8.1 Sensors and measuring instruments

Temperature sensors

The product range includes high-precision platinum temperature sensors, flatscrew sensors, outdoor temperature sensors, indoor temperature sensors, cylindrical clip-on sensors, also as complete sensors with immersion sleeve.

Order information can be found in our catalogue and on our Web site.

SP10 Overvoltage protection device

In order to avoid overvoltage damage at collector sensors (e.g. caused by local lightning storms), we recommend installing the overvoltage protection SP10.

VFD Grundfos Direct Sensors™

The VFD Grundfos Direct Sensor™ is a digital sensor that measures both temperature and flow rate.

8.2 VBus® accessories

SD3 Smart Display

The Smart Display is designed for simple connection to controllers with VBus®. It is used for visualising data issued by the controller: collector temperature, store temperature and energy yield of the solar thermal system. The use of high-efficiency LEDs and filter glass assures a high optical brilliance. An additional power supply is not required.

GA3 Large display module

The GA3 is a completely mounted large display module for visualisation of collector- and store temperatures as well as the heat quantity yield of the solar system via one 6-digit and two 4-digit 7-segment-displays. An easy connection to all controllers with VBus® is possible. The front plate is made of antireflective filterglass and is printed with a light-resistant UV-lacquering. The universal VBus® allows the parallel connection of 8 large displays as well as additional VBus® modules.

AM1 Alarm Module

The AM1 Alarm Module is designed to signal system failures. It is to be connected to the VBus® of the controller and issues an optical signal via the red LED if a failure has occurred. The AM1 also has a relay output, which can e. g. be connected to a building management system (BMS). Thus, a collective error message can be issued in the case of a system failure.

The AM1 Alarm module ensures that occurring failures can be immediately recognised and repaired, even if the system and the controller are difficult to access or located in a remote place. Thus, the reliability and the stable yield of the system are ensured.

DL2 Datalogger

This additional module enables the acquisition and storage of large amounts of data (such as measuring and balance values of the solar system) over a long period of time. The DL2 can be configured and read-out with a standard Internet browser via its integrated web interface. For transmission of the data stored in the internal memory of the DL2 to a PC, an SD card can be used. The DL2 is appropriate for all controllers with VBus®. It can be connected directly to a PC or router for remote access and thus enables comfortable system monitoring for yield monitoring or for diagnostics of faults.

DL3 Datalogger

Be it solar thermal, heating or DHW heat exchange controllers – with the DL3 you can easily and conveniently log system data of up to 6 controllers. Get a comprehensive overview of all controllers connected with the large full graphic display. Transfer data with an SD memory card, or use the LAN interface to view and process data on your PC.

8.3 Interface adapters

VBus®/USB interface adapter

The VBus®/USB interface adapter is the interface between the controller and a personal computer. With its standard mini USB port it enables a fast transmission of system data for processing, visualising and archiving as well as the parametrisation of the controller via the VBus®. The ServiceCenter software is included.

VBus®/LAN interface adapter

The VBus®/LAN interface adapter is designed for the direct connection of the controller to a PC or router. It enables easy access to the controller via the local network of the owner. Thus, controller access, system parameterisation and data charting can be effected from every workstation of the network. The VBus®/LAN interface adapter is suitable for all controllers equipped with a VBus®. The ServiceCenter software is included.

A		L	
Accessories.....	27, 28	Language.....	22
Antifreeze function	19	M	
C		Minimum collector temperature	19
Collector cooling	18	Monitoring-Display	9
Collector emergency shutdown.....	17	Mounting.....	5
Commissioning.....	11	O	
Cooling function.....	17	Operating mode.....	22
D		S	
ΔT control.....	15	Speed control.....	16
Data communication / Bus.....	6	Store cooling.....	19
Displays.....	9	System screen.....	10
Drainback option	21	T	
E		Technical data.....	4
Electrical connection.....	5	Troubleshooting.....	24
F			
Flow rate.....	14, 20		
H			
Heat quantity measurement.....	20		
Holiday.....	19		

Distributed by:

RESOL – Elektronische Regelungen GmbH

Heiskampstraße 10
45527 Hattingen / Germany

Tel.: +49 (0) 23 24 / 96 48 - 0

Fax: +49 (0) 23 24 / 96 48 - 755

www.resol.com
info@resol.com

Important note

The texts and drawings in this manual are correct to the best of our knowledge. As faults can never be excluded, please note:

Your own calculations and plans, under consideration of the current standards and directions should only be basis for your projects. We do not offer a guarantee for the completeness of the drawings and texts of this manual - they only represent some examples. They can only be used at your own risk. No liability is assumed for incorrect, incomplete or false information and / or the resulting damages.

Note

The design and the specifications can be changed without notice.

The illustrations may differ from the original product.

Imprint

This mounting- and operation manual including all parts is copyrighted. Another use outside the copyright requires the approval of **RESOL – Elektronische Regelungen GmbH**. This especially applies for copies, translations, micro films and the storage into electronic systems.