

DeltaTherm® FK

RESOL®

Solid fuel boiler controller

Manual for the
specialised craftsman

Mounting

Electrical connection

Application examples

Operation

Troubleshooting



11204753



Your mobile remote display

Thank you for buying this RESOL product.
Please read this manual carefully to get the best performance from this unit.
Please keep this manual safe.

en

Manual

www.resol.com

Safety advice

Please pay attention to the following safety advice in order to avoid danger and damage to people and property.

Instructions

Attention must be paid to the valid local standards, regulations and directives!

Information about the product

Proper usage

The solar controller is designed for use with heating systems with a solid fuel boiler in compliance with the technical data specified in this manual.

Improper use excludes all liability claims.

CE Declaration of conformity

The product complies with the relevant directives and is therefore labelled with the CE mark. The Declaration of Conformity is available upon request, please contact RESOL.



Note:

Strong electromagnetic fields can impair the function of the device.

- Make sure the device as well as the system are not exposed to strong electromagnetic fields.

Subject to technical change. Errors excepted.

Target group

These instructions are exclusively addressed to authorised skilled personnel. Only qualified electricians should carry out electrical works.

Description of symbols

WARNING! Warnings are indicated with a warning triangle!



→ **They contain information on how to avoid the danger described.**

Signal words describe the danger that may occur, when it is not avoided.

- **WARNING** means that injury, possibly life-threatening injury, can occur.
- **ATTENTION** means that damage to the appliance can occur.



Note:

Notes are indicated with an information symbol.

- Arrows indicate instruction steps that should be carried out.

Disposal

- Dispose of the packaging in an environmentally sound manner.
- Dispose of old appliances in an environmentally sound manner. Upon request we will take back your old appliances bought from us and guarantee an environmentally sound disposal of the devices.

Contents

1	Installation	5
1.1	Mounting	5
1.2	Electrical connection	6
1.3	Data communication / VBus®	6
2	Sensor and relay allocation	7
3	Operation and function	12
3.1	Adjustment buttons	12
3.2	Operating concept	12
4	Commissioning	13
5	Display mode	16
5.1	System screen and balance diagrams	16
5.2	Measured values	16
5.3	Balance values	17
6	Functions and options	18
7	User code	29
8	Menu structure	29
9	Troubleshooting	32
10	Accessories	33
11	Index	35

- Full graphic display
- Intuitive menu navigation through easy-to-understand symbols
- Function control
- Graphic balancing
- 2 relay outputs, 4 temperature sensor inputs
- 2 PWM outputs for the speed control of high-efficiency pumps
- Control of an electronic mixer for the return mixing function
- Return preheating (heating backup)
- Heat exchange function
- Thermostatic afterheating

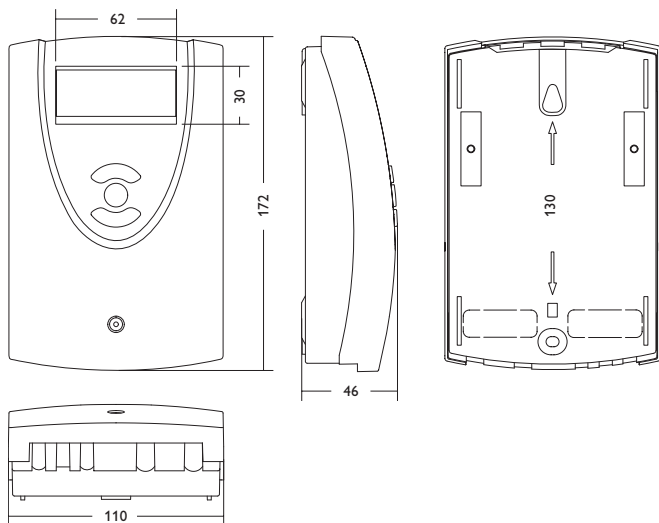
**Technical data:**

Inputs: for 4 Pt1000 temperature sensors

Outputs: 2 semiconductor relays, 2 PWM outputs

PWM frequency: 1000 Hz

PWM voltage: 10,5 V

Switching capacity: 1 (1) A 240 V~ (semiconductor relay)

Total switching capacity: 2 A 240 V~

Power supply: 100 ... 240 V~ (50 ... 60 Hz)

Supply connection: type Y attachment

Power consumption < 1 W (Standby)

Mode of operation: type 1.Y

Rated impulse voltage: 2,5 KV

Data interface: RESOL VBus®

VBus® current supply: 35 mA

Functions: minimum and maximum temperature limitation, mixer control for the return mixing function, target temperature control, speed control, return preheating (heating circuit backup), thermostatic afterheating, PWM pump control, operating hours counter, balance values

Housing: plastic, PC-ABS and PMMA

Mounting: wall mounting, also suitable for mounting into patch panels

Indication / Display: Full graphic display

Operation: 3 push buttons at the front of the housing

Protection type: IP 20 / DIN EN 60529

Protection class: I

Ambient temperature: 0 ... 40 °C

Degree of pollution: 2

Dimensions: 172 x 110 x 46 mm

1 Installation

1.1 Mounting

The unit must only be installed

- in a dry interior location
- in a non-hazardous location
- not close electromagnetic fields

The controller must additionally be supplied from a double pole switch with contact gap of at least 3 mm [0.12"] .

Route sensor cables and power supply cables separately.

- ➔ Unscrew the crosshead screw of the front cover and remove the cover by pulling it downwards
- ➔ Mark the upper fastening point on the wall and drill
- ➔ Fasten one of the enclosed wall plugs and screw leaving the head protruding
- ➔ Hang the housing at the upper fastening point
- ➔ Mark the lower fastening point through the hole in the terminal box (centres 130 mm)
- ➔ Drill and insert the wall plug
- ➔ Hang the housing at the upper fastening point, fasten it to the wall with the fastening screw and tighten
- ➔ Complete wiring connections in accordance with terminal allocations, see chap.1.2 "Electrical connection"
- ➔ Put the cover on the housing
- ➔ Fasten the cover by means of the cross-head screw

WARNING! Electric shock!



Upon opening the housing, live parts are exposed!

- ➔ **Always disconnect the controller from power supply before opening the housing!**

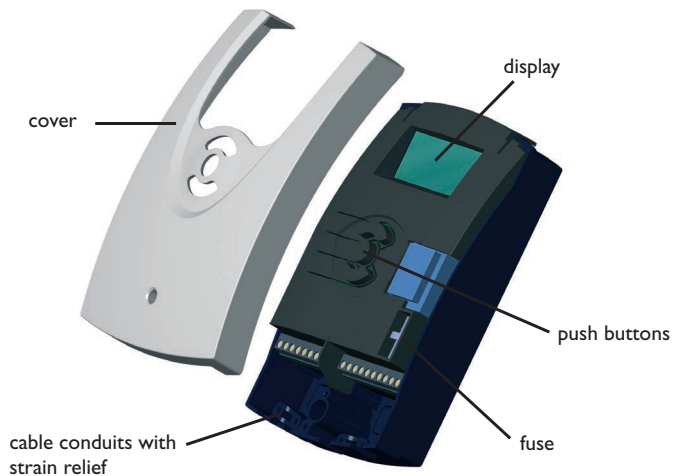

1.2 Electrical connection

WARNING! Electric shock!



Upon opening the housing, live parts are exposed!

→ **Always disconnect the controller from power supply before opening the housing!**



Note:

Connecting the device to the mains supply must always be the last step of the installation! The power supply of the controller must be carried out via an external power switch.

The supply voltage must be 100... 240 V~ (50... 60 Hz). The controller is equipped with 2 relays in total to which loads such as pumps, or a mixer, etc. can be connected:

Relay 1

18 = conductor R1

17 = neutral conductor N

11 = protective earth conductor

Relay 2

16 = conductor R2

15 = neutral conductor N

12 = protective earth conductor

Connect the **VBus**® to the terminals marked "VBus" with either polarity.

The terminals marked PWM1/2 are control outputs for high-efficiency pumps.

Connect the **temperature sensors** (S1 to S4) to the following terminals with either polarity:

S1 = Sensor 1 (sensor SFB/ stove)

S2 = Sensor 2 (sensor store base)

S3 = Sensor 3 (sensor store top)

S4 = Sensor 4 (system-dependent)



Note:

In order to connect sensor 4 to the controller, a sensor adapter cable is required, see page 33.

The **mains connection** is at the terminals:

19 = neutral conductor N

20 = conductor L

13 = protective earth conductor



Note:

If no indication is made on the display, the fuse may be blown. Replace it with the spare fuse included with the device. For this purpose, pull the fuse holder from the base.

WARNING! ESD damage!



Electrostatic discharge can lead to damage to electronic components!

→ **Take care to discharge properly before touching the inside of the device! To do so, touch a grounded surface such as a radiator or tap!**

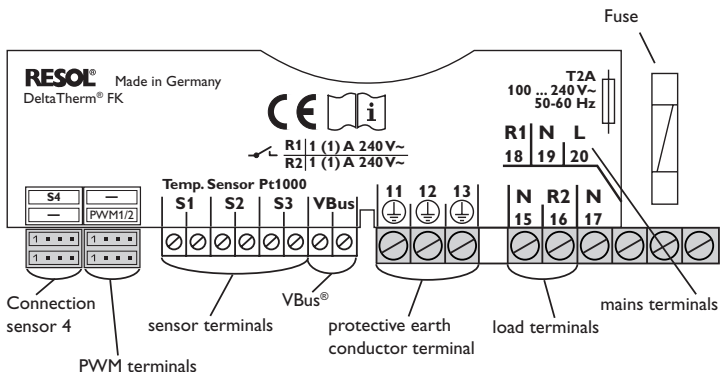

1.3 Data communication/VBus®

The controller is equipped with the RESOL **VBus**® for data transfer and energy supply to external modules. The connection is to be carried out at the two terminals marked **VBus** and **GND** (any polarity).

One or more RESOL VBus® modules can be connected via this data bus, such as:

- DL2 Datalogger
- DL3 Datalogger
- VBus® / USB or VBus® / LAN interface adapters
- AM1 Alarm module
- SDFK

2 Sensor and relay allocation

System overview:

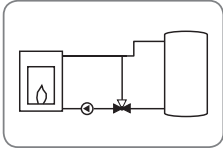

System 1: Solid fuel boiler system (with representation of mixer)

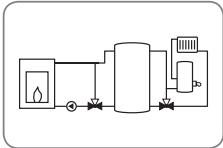

System 2: Solid fuel boiler system with return preheating (with representation of mixer)

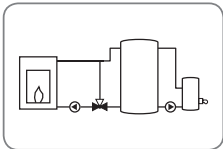

System 3: Solid fuel boiler system with afterheating (with representation of mixer)

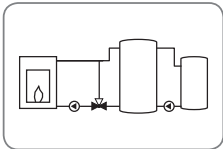

System 4: Solid fuel boiler system with heat exchange (with representation of mixer)

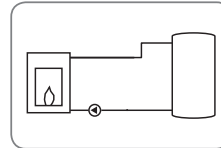

System 5: Solid fuel boiler system (without representation of mixer)

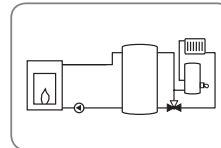

System 6: Solid fuel boiler system with return preheating (without representation of mixer)

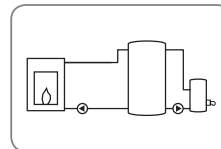

System 7: Solid fuel boiler system with afterheating (without representation of mixer)

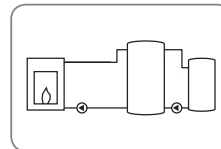

System 8: Solid fuel boiler system with heat exchange (without representation of mixer)

System 1 and 5 Solid fuel boiler system

- en
- Installation
- Commissioning
- Display
- Settings
- Troubleshooting
- Accessories

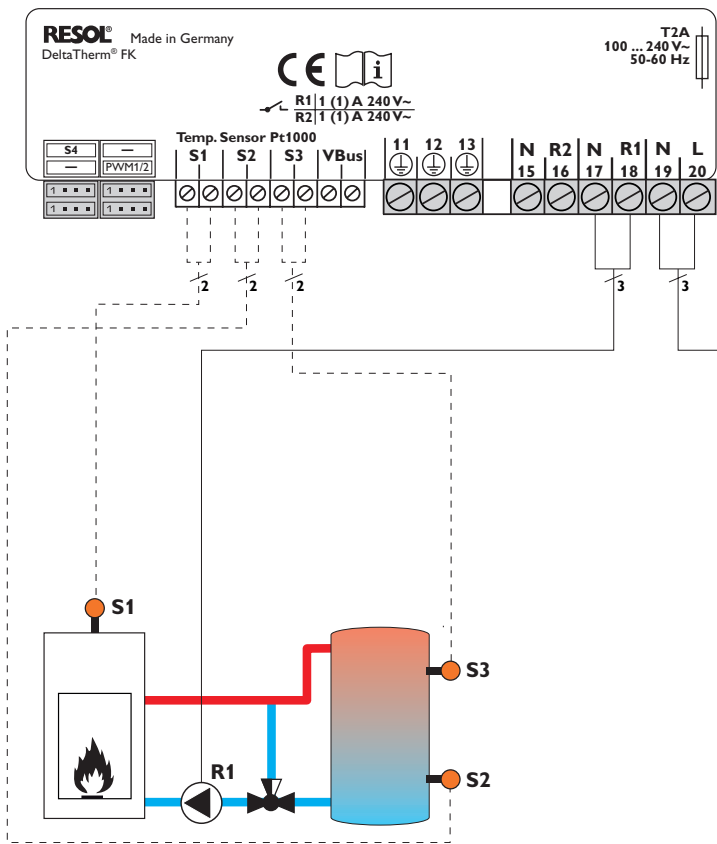

Sensor allocation

S1	S2	S3
Solid fuel boiler	Store base	Store top

Relay allocation

PE			R1		R2		Mains	
11	12	13	17	18	15	16	19	20
⊕			N	L	N	L	N	L
Protective conductor			Pump		Free		Mains	

The controller calculates the temperature difference between solid fuel boiler sensor S1 and store sensor S2. If the difference is larger than or identical to the adjusted switch-on temperature difference and if the adjusted minimum temperature of the solid fuel boiler, the pump (R1) will be switched on and the store will be loaded until the switch-off temperature difference or the maximum store temperature is reached.

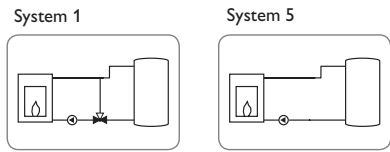

System 2 and 6 Store loading via solid fuel boiler and return preheating

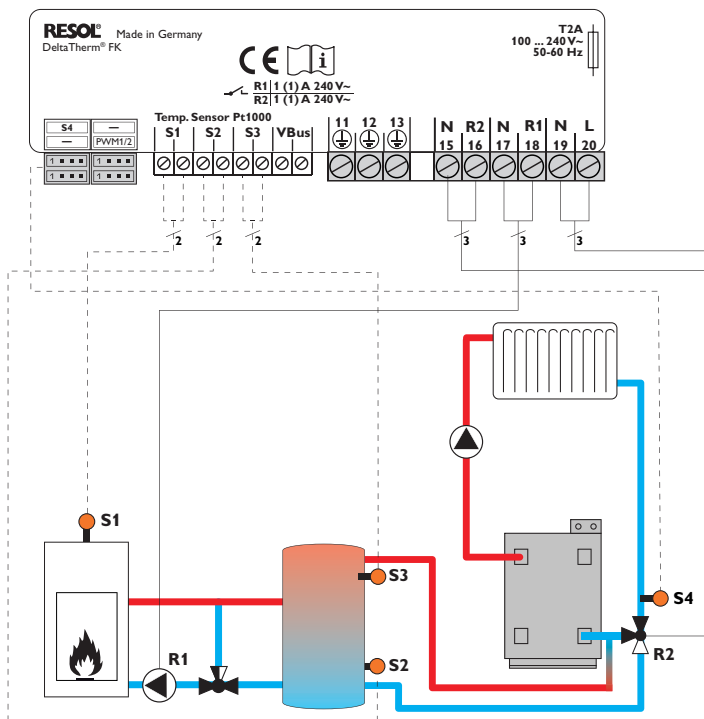

Sensor allocation

S1	S2	S3	S4
Solid fuel boiler	Store base	Store top	Heating circuit return

Relay allocation

PE			R1		R2		Mains	
11	12	13	17	18	15	16	19	20
⊖			N	L	N	L	N	L
Protective earth conductor			Pump		Return valve		Mains	

The controller calculates the temperature difference between solid fuel boiler sensor S1 and store sensor S2. If the difference is larger than or identical to the adjusted switch-on temperature difference and if the adjusted minimum temperature of the solid fuel boiler, the pump (R1) will be switched on and the store will be loaded until the switch-off temperature difference or the maximum store temperature is reached.

With another temperature differential function (S3 heat source / S4 heat sink) return preheating (heating circuit backup) is possible via a valve (R2).

System 2

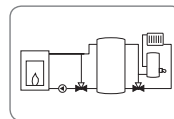

System 6

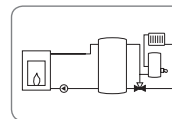

System 3 and 7

Store loading via solid fuel boiler and afterheating

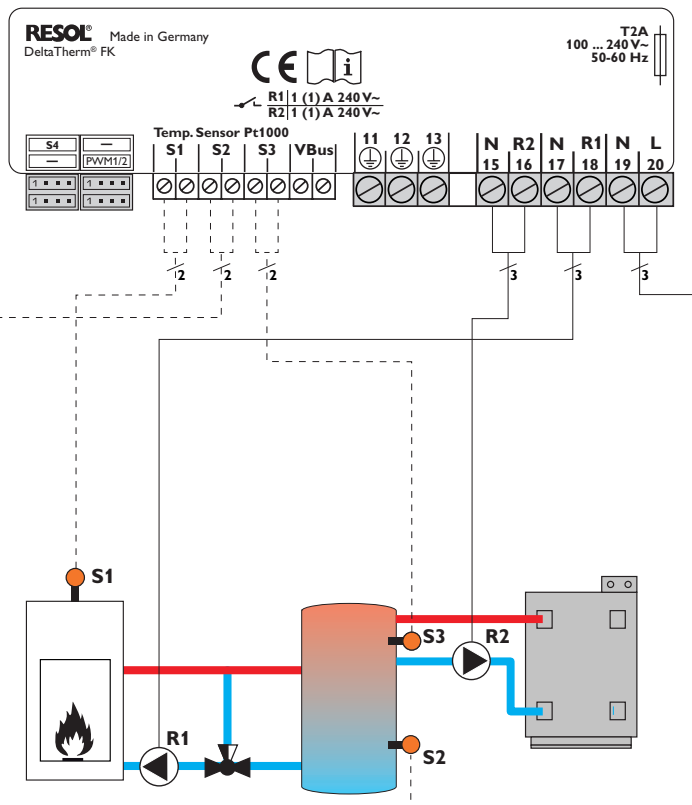

Sensor allocation

S1	S2	S3
Solid fuel boiler	Store base	Store top

Relay allocation

PE			R1		R2		Mains	
11	12	13	17	18	15	16	19	20
⊕			N	L	N	L	N	L
Protective earth conductor			Pump		Afterheating		Mains	

The controller calculates the temperature difference between solid fuel boiler sensor S1 and store sensor S2. If the difference is larger than or identical to the adjusted switch-on temperature difference and if the adjusted minimum temperature of the solid fuel boiler, the pump (R1) will be switched on and the store will be loaded until the switch-off temperature difference or the maximum store temperature is reached.

Afterheating (R2) can be carried out with a thermostat function (S3). If the value at S3 reaches the switch-on temperature for the afterheating, the relay is switched on. If the value exceeds the switch-off temperature for the afterheating, the relay is switched off again.

System 3

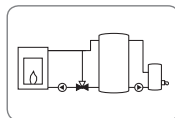

System 7

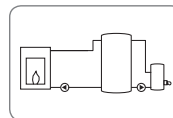

System 4 and 8

Store loading via solid fuel boiler and heat exchange

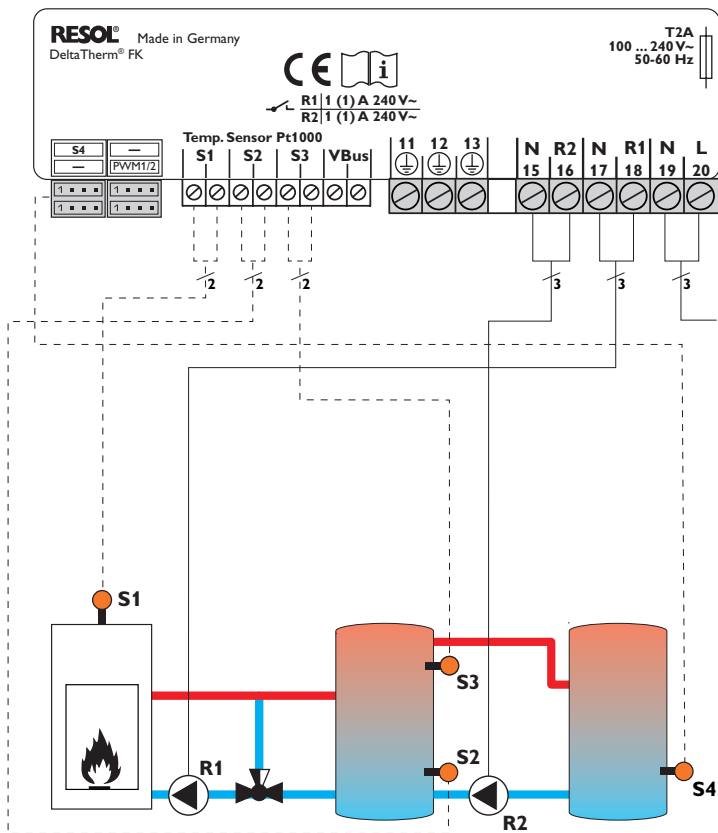

Sensor allocation

S1	S2	S3	S4
Solid fuel boiler	Store base	Store top	Store 2

Relay allocation

PE	R1	R2	Mains
11 12 13	17 18	15 16	19 20
⊕	N L	N L	N L
Protective earth conductor	Pump	Store loading pump	Mains

The controller calculates the temperature difference between solid fuel boiler sensor S1 and store sensor S2. If the difference is larger than or identical to the adjusted switch-on temperature difference and if the adjusted minimum temperature of the solid fuel boiler, the pump (R1) will be switched on and the store will be loaded until the switch-off temperature difference or the maximum store temperature is reached.

Heat exchange control to an existent store via an additional pump (R2) can be carried out with another temperature differential function (S3 heat source/S4 heat sink).

System 4

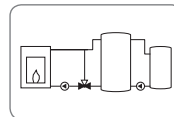

System 8

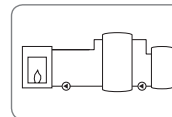

3 Operation and function

3.1 Adjustment buttons

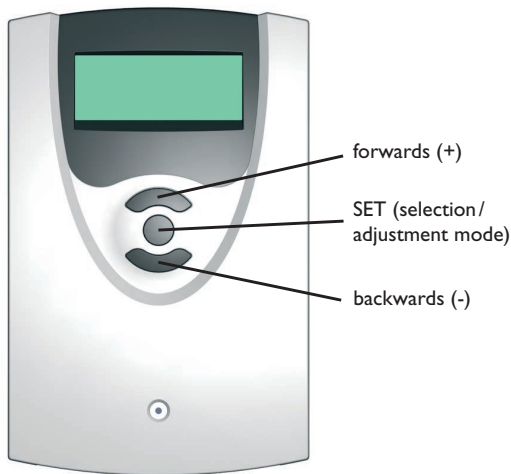

The controller is operated via the 3 push buttons below the display.

The upper button (+) is used for scrolling forwards through the display menu or to increase adjustment values.

The lower button (-) is used for scrolling backwards through the display menu or to reduce adjustment values.

The centre button is used for selecting channels and confirming adjustments.

3.2 Operating concept

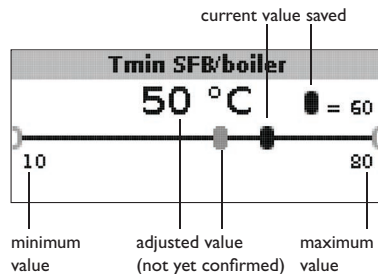

Adjustment mode

In the adjustment values menu, different functions and values can be selected and adjusted.

➔ Press the centre button for 3 s to access the adjustment menu

Adjusting a value:

➔ Select the value with the lower and upper buttons.

➔ Briefly press the centre button; the adjustment range is displayed as a slide bar.

➔ Adjust the desired value by pressing the upper and the lower buttons; the value is displayed with the cursor on the slide bar.

➔ Briefly press the centre button to confirm the adjustment.

➔ Press the centre button again in order to store the adjustment and to get back to the adjustment menu.

If the centre button is not pressed after an adjustment has been made, the display switches back to the menu after a few seconds. The adjusted value will not be stored in that case.

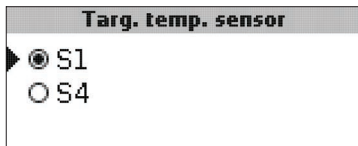

Selecting a function or option:

- Select the function or the option respectively with the lower and upper buttons
- Press the centre button
- Select **Yes** to activate, or **No** to deactivate the function
- Briefly press the lower button to confirm the selection
- Press the centre button again in order to store the adjustment

An activated function is indicated by means of a marked checkbox. The corresponding adjustment values are also displayed.

- In order to get back to the display mode, press the centre button for 3 s

If no button is pressed within 2 min, the display automatically switches back to the status display.

4 Commissioning

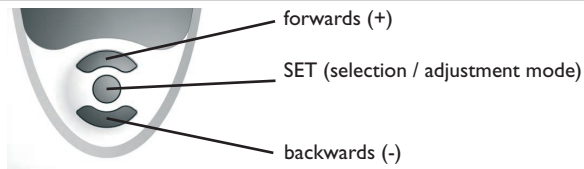

The three adjustment buttons of the DeltaTherm® FK controller

- Connect the device to the mains

The controller runs an initialisation phase.

When the controller is commissioned or when it is reset, it will run a commissioning menu. The commissioning menu leads the user through the most important adjustment channels needed for operating the system.

Commissioning menu

- Press the centre button in order to select an adjustment channel
- Press the lower and the upper buttons in order to adjust the value
- Briefly press the centre button to confirm the adjusted value
- Press the lower or the upper buttons in order to get to the next or the previous adjustment channel

The commissioning menu consists of the following 10 adjustment channels:

1. Language

- Adjust the desired menu language.
- language selection
 Selection: Deutsch, English, Français, Italiano, Español
 Factory setting: German

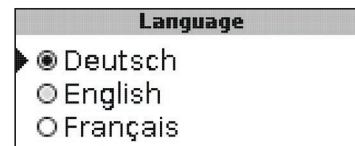

2. Unit

- Adjust the desired unit for temperature indication.
- Temperature unit
 Selection: °C, °F
 Factory setting: °C

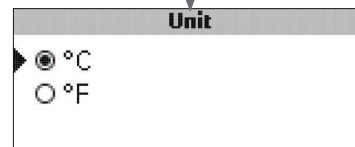

3. Time

- Adjust the current time for the real-time clock.
- Adjust the hours and the minutes separately, first of all the hours, then the minutes.

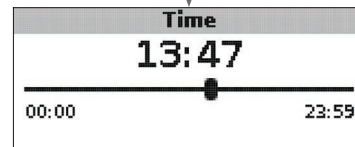

Real-time clock

Commissioning menu

4. Date

→ Adjust the date.

Current date

Adjustment range:

01.01.2001... 31.12.2099

5. System

→ Adjust the desired system scheme for the system

For a detailed description of the system schemes to choose from, see chap. 2.

If the system layout selection is changed later on, any previous adjustments which have been made in the other channels will be lost.

System selection

Adjustment range: 1 ... 8

Factory setting: 1

6. Minimum temperature of the solid fuel boiler

→ Adjust the desired minimum temperature of the solid fuel boiler

T_{min} SFB / boiler

Minimum temperature of the solid fuel boiler

Adjustment range: 10... 80 °C

Factory setting: 60 °C

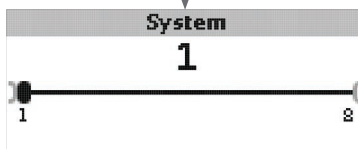
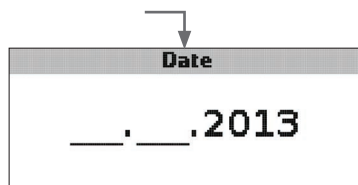

7. Switch-on temperature difference SFB / boiler

→ Adjust the desired switch-on temperature difference

ΔT_{on} SFB / boiler

Switch-on temperature difference solid fuel boiler

Adjustment range: 1.0... 25.0 K

Factory setting: 6.0 K



Note:

The switch-on temperature difference must be at least 0.5 K higher than the switch-off temperature difference. The adjustment range will automatically adapt to that.

8. Switch-off temperature difference

→ Adjust the desired switch-off temperature difference

ΔT_{off} SFB / boiler

Switch-off temperature difference solid fuel boiler

Adjustment range: 0.5... 24.5 K

Factory setting: 4.0 K



Note:

The switch-off temperature difference must be at least 0.5 K lower than the switch-on temperature difference. The adjustment range will automatically adapt to that.

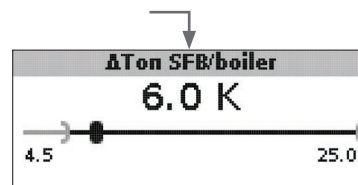

Commissioning menu

9. Maximum store temperature

→ Adjust the desired maximum store temperature

Tmax store

Maximum store temperature (cursor)

Adjustment range: 30... 90 °C

Factory setting: 90 °C

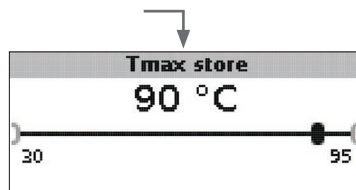

10. Emergency shutdown temperature

→ Adjust the desired emergency shutdown temperature of the solid fuel boiler

Temerg SFB/boiler

Emergency shutdown temperature

Adjustment range: 80... 105 °C

Factory setting: 95 °C

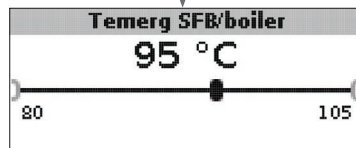

11. Save

Completing the commissioning menu

The last menu item of the commissioning menu is **Save**. If you select **Save**, all adjustments carried out in the commissioning menu will be confirmed and saved.

→ In order to confirm the adjustments made in the commissioning menu, press button 3

The controller is then ready for operation with the adjustments made for the selected system.

The adjustments carried out during commissioning can be changed after commissioning anytime in the corresponding adjustment channel.

Additional functions and options can also be activated or deactivated.

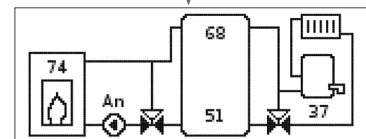

5 Display mode

5.1 System screen and balance diagrams

During normal operation the display shows the system screen.

→ In order to access the display menu of measured and balance values as well as the adjustment menu, press the centre button for 3 s

System screen

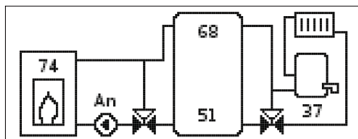

The system screen shows the system selected. Different measured values, pump speed values and valve states can also be read from the screen.

Balance diagrams

In the balance diagrams, the following temperature courses are charted over time:

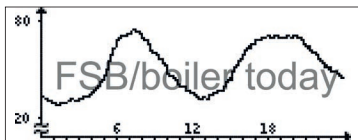

SFB/Boiler yesterday

St. base today

St. base yesterd.

St. top today

St. top yesterd.

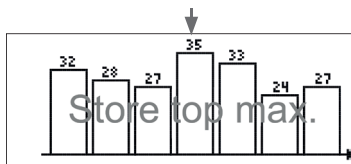

This balance diagram shows the maximum temperatures of the last 7 days measured at the upper store sensor.

5.2 Measured values

The measured values display shows the following values, depending on the system selected.

-- Measured values --

► SFB/boiler	43 °C
Store base	60 °C
Store top	26 °C
Sensor 4	
SFB/boiler flow	
SFB/boiler return	
Heating ret.	
Store 2	
SFB/boiler pump	
Mixer open	
Mixer close	
Store loading pump	
Return valve	
Time	
Date	

5.3 Balance values

The balance values display shows the following values, depending on the system selected.

Max. SFB / boiler

Display of the maximum solid fuel boiler temperature in °C measured since commissioning or last reset.

Max. store base

Display of the maximum store temperature at the bottom in °C measured since commissioning or last reset.

Max. store top

Display of the maximum store temperature at the top in °C measured since commissioning or last reset.

Max. SFB/boiler flow

Display of the maximum temperature of the solid fuel boiler / boiler flow in °C measured since commissioning or last reset.

Max. SFB/boiler return

Display of the maximum temperature of the solid fuel boiler / boiler return in °C measured since commissioning or last reset.

Max. HC ret

Display of the maximum temperature of the heating return in °C measured since commissioning or last reset.

Max. store 2

Display of the maximum temperature of store 2 in °C measured since commissioning or last reset.

Oper. hours R1

Display of operating hours of relay 1 since commissioning or last reset.

Oper. hours R2

Display of operating hours of relay 2 since commissioning or last reset.

Operating days

Display of operating days of the device since commissioning or last reset.

-- Balance values: --	
Max. SFB/boiler	43 °C
Max. store base	60 °C
▶ Max. store top	26 °C

The balance values can be set back to zero in the balance and adjustment menu.

→ Press the centre button for 3 s.

The display shows the balance and adjustment menu.

→ Select the balance value to be reset with the lower and upper buttons.

→ Briefly press the centre button.

A security enquiry appears.

Max. SFB/boiler	
Delete?	No

→ Confirm the security enquiry by with **Yes**

The value will then be set back to zero.

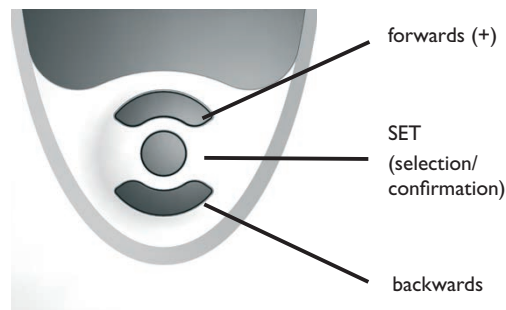

6 Functions and options

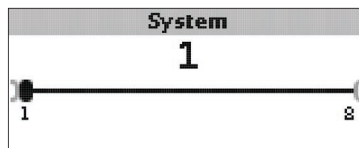

System

System selection

Adjustment range: 1 ... 8

The system has been adjusted during commissioning.

For a detailed description of the system schemes to choose from, see chap. 2.



Note:

If the system layout selection is changed later on, any previous adjustments which have been made in the other channels will be lost.

Boiler minimum limitation



Tmin SFB / boiler

Boiler minimum temperature

Adjustment range: 10 ... 80 °C

Factory setting: 60 °C



ΔTmin SFB / boiler

Hysteresis SFB / boiler minimum limitation

Adjustment range: 3.0 ... 15.0 K

Factory setting: 5.0 K

In order to avoid condensation in the SFB / boiler caused by cooling of the store return at low SFB / boiler flow temperatures, the minimum SFB / boiler temperature T_{min} SFB / boiler can be adjusted.

Only if the temperature at sensor S1 is exceeded, will the controller switch on the circulating pump. If the temperature at sensor 1 falls by the hysteresis ΔT_{min} SFB/boiler (adjustable in the **Installer** menu) below the SFB / boiler minimum temperature, the controller switches off the circulating pump.

Differential control



ΔTon SFB / boiler

Switch-on temperature difference SFB / boiler

Adjustment range: 1.0 ... 25.0 K

Factory setting: 5.0 K



Note:

The switch-on temperature difference must be at least 0.5 K higher than the switch-off temperature difference. The adjustment range will automatically adapt to that.



ΔToff SFB / boiler

Switch-off temperature difference SFB / boiler

Adjustment range: 0.0 ... 24.5 K

Factory setting: 4.0 K



Note:

The switch-off temperature difference must be at least 0.5 K lower than the switch-on temperature difference. The adjustment range will automatically adapt to that.

If the switch-on difference $\Delta T_{\text{on SFB/boiler}}$ between sensor S1 in the SFB/boiler and the lower store sensor (S2) is exceeded, the controller switches on the circulating pump and the store is loaded. If the temperature difference between the SFB / boiler and the lower store sensor falls below the switch-off difference $\Delta T_{\text{off SFB/boiler}}$, loading will switch off.

The lower part of the store will no longer be loaded if the SFB / boiler is blocked (see SFB / boiler minimum and maximum limitation) or the temperature measured at the lower store sensor has exceeded the maximum temperature. The controller switches off the circulating pump or keeps it switched off.

Speed control

(adjustable in the **Installer** menu)



$\Delta T_{\text{set SFB / boiler}}$

Set temperature difference

Adjustment range: 0.5... 50.0 K

Factory setting: 10.0 K

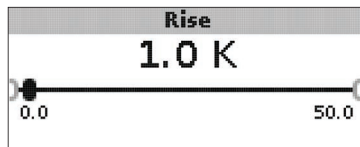

Rise

Rise value speed control

Adjustment range: 0.0... 50.0 K

Factory setting: 1.0 K

If the switch-on difference is reached, the pump switches on at full speed for 10 s. Then, the speed is reduced to the adjusted minimum pump speed value.

If the temperature difference reaches the adjusted set temperature difference $\Delta T_{\text{set SFB/boiler}}$, the speed will increase by one step (control type Std. = 10%, control type PWM = 1%). If the temperature difference increases by the adjustable value **rise**, the pump speed increases by another step until the maximum pump speed of 100 % is reached.

Target temperature control

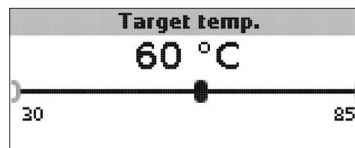

Target temperature

Target temperature for speed control

Adjustment range: 30... 85 °C

Factory setting: 60 °C

The controller controls the speed of the circulating pump in order to reach or keep the target temperature at the target sensor.

If the temperature measured at the target sensor is lower than the target temperature, the circulating pump will be controlled with the minimum speed. If the temperature measured at the target temperature sensor exceeds the target temperature, the speed of the circulating pump will be increased depending on the temperature difference to the maximum speed.

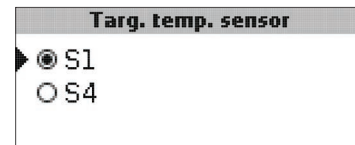

Targ. temp. sensor

Reference sensor for target temperature control

Selection: S1, S4

Factory setting: S1

The adjustment channel **Targ. temp. sensor** is used for selecting the sensor for target temperature control. This way, the position of the sensor in the store flow can be taken into account.

Store reference sensor

Ref. sensor store

- S2
 S3

Ref. sensor store

Reference sensor store loading

Selection: S2, S3

Factory setting: S2

The adjustment channel reference sensor store is used for selecting the sensor to be used as the reference sensor for store loading.

Maximum store temperature

Tmax store

90 °C

30

95

Tmax store

Maximum store temperature

Adjustment range: 30... 95 °C

Factory setting: 90 °C

If the temperature measured at the lower store sensor exceeds the adjusted maximum store temperature, the controller switches off the **SFB / boiler**. The store will no longer be loaded, in order to reduce the risk of scalding and system damage. A hysteresis for the maximum store temperature can be adjusted in the **Installer** menu.

Max. sensor

- S2
 S3

Max. sensor

Reference sensor store maximum temperature

Selection: S2, S3

Factory setting: S3

The adjustment channel **Max. sensor** is used for selecting the sensor to be used as the reference sensor for the maximum store temperature.

Boiler maximum limitation

Temerg SFB/boiler

95 °C

80

105

Temerg SFB / boiler

Adjustment range: 80... 105 °C

Factory setting: 95 °C

ΔTmax SFB/boiler

5.0 K

1.0

25.0

ΔTmax SFB / boiler

Hysteresis SFB / boiler maximum limitation

Adjustment range: 1.0... 25.0K

Factory setting: 5.0K

In order to limit the flow temperature of the SFB / boiler to a maximum value, a maximum SFB / boiler temperature Temerg SFB / boiler can be adjusted in addition to the discharge safety device.

If this temperature is reached at sensor S1, the controller switches off the circulating pump.

If the flow temperature has exceeded the SFB / boiler maximum temperature and if the temperature has fallen by the hysteresis ΔTmax SFB/boiler (adjustable in the **Installer** menu) below **Temerg / SFB / boiler** measured at sensor 1, the circulating pump switches on again.

Mixer

(in systems 1 and 5 only)



Note:

The mixer option can only be used, if a high-efficiency pump with PWM speed control is used as the solid fuel boiler pump!

The mixer function can be used for adjusting the SFB / boiler return temperature to the mixer target temperature. If the mixer target temperature is exceeded by at least 2 K, the mixer will be controlled with the adjusted interval.

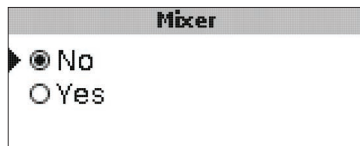

Mixer

Selection: Yes, No

Factory setting: No

If the mixer option is activated, both relays are required for controlling the mixer:

Relay 1 = mixer open

Relay 2 = mixer closed

The power supply of the pump must be carried out externally. The pump is speed controlled via the PWM output.

Connecting a mixer and a HE pump

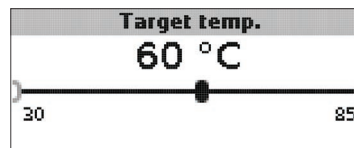
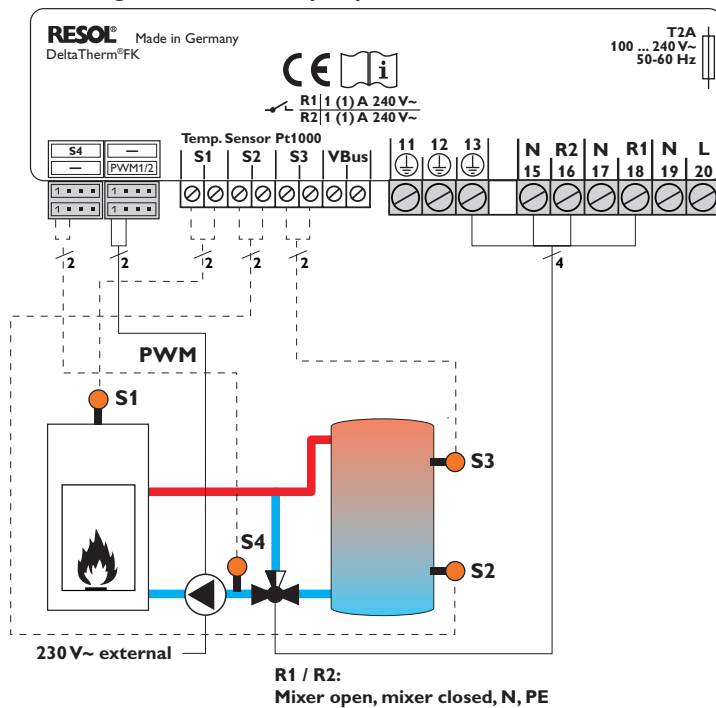

Target temperature

Adjustment range: 30 ... 85 °C

Factory setting: 60 °C

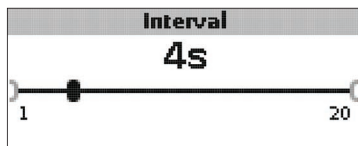
**Interval**

Adjustment range: 1 ... 20 s

Factory setting: 4 s

**Note:**

If the mixer option is activated, both relays are required for controlling the mixer. The power supply of the pump must be carried out externally. The pump is speed controlled via the PWM output.

Return preheating

(in systems 2 and 6 only)

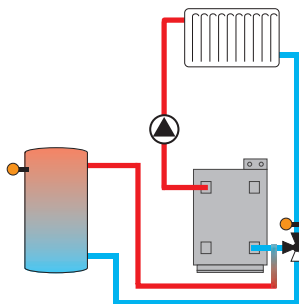

The return preheating function can be used for transferring heat from a heat source to the heating circuit return.

The relay R2 is energised when the following switch-on conditions are fulfilled:

- The temperature difference between the RPH sensor (S2 or S3) and S4 has exceeded the switch-on temperature difference.
- The temperature at the RPH sensor has exceeded Tmin ST RPH.
- The temperature at S4 has exceeded Tmin RPH.

**Note:**

In systems with floor heating, Tmin RPH may have to be set to 10 °C.

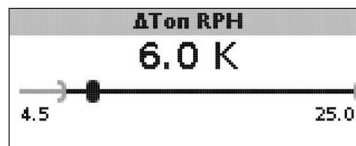
**ΔTon RPH**

Adjustment range: 1.0 ... 25.0 K

Factory setting: 6.0 K

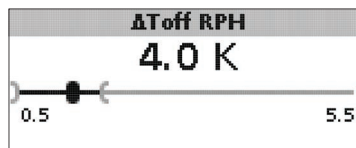
**ΔToff RPH**

Adjustment range: 0.5 ... 24.5 K

Factory setting: 4.0 K

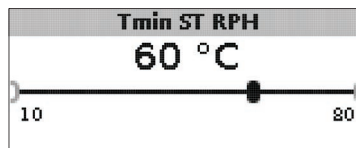
**Tmin ST RPH**

Adjustment range: 10 ... 80 °C

Factory setting: 60 °C

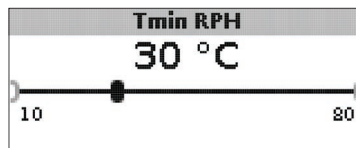
**Tmin RPH**

Adjustment range: 10 ... 80 °C

Factory setting: 30 °C



RPH sensor

Selection: S2, S3

Factory setting: S3

Thermostat function

(in systems 3 and 7 only)

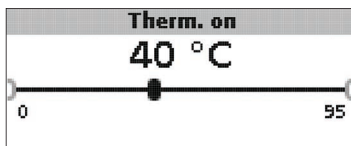

Therm. on:

Thermostat switch-on temperature

Adjustment range: 0.0 ... 95.0 °C

Factory setting: 40.0 °C

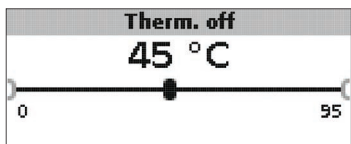

Therm. off:

Thermostat switch-off temperature

Adjustment range: 0.0 ... 95.0 °C

Factory setting: 45.0 °C



Switch-on time 1 (2, 3):

Thermostat switch-on time

Adjustment range: 00:00 ... 23:59

Factory setting:

Switch-on time 1: 06:00

Switch-on time 2: 12:00

Switch-on time 3: 18:00



Switch-off time 1 (2, 3)

Thermostat switch-off time

Adjustment range: 00:00 ... 23:59

Factory setting:

Switch-off time 1: 07:00

Switch-off time 2: 13:00

Switch-off time 3: 20:00

The thermostat function can e. g. be used for using surplus energy or for afterheating.

- **Therm. on < Therm. off**
thermostat function used for afterheating
- **Therm. on > Therm. off**
thermostat function used for using surplus energy

In order to block the thermostat function for a certain period, there are 3 time frames. If the thermostat function is supposed to run from 06:00 a.m. and 09:00 a.m. only, adjust the **switch-on time 1** to 06:00 a.m. and the **switch-off time 1** to 09:00 a.m.

Heat exchange

(in systems 4 and 8 only)

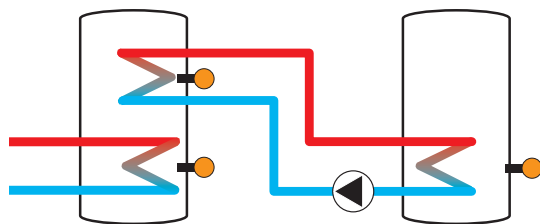

ΔT_{on} heat exch.

6.0 K

1.0 50.0

ΔT_{on} heat exch.

Switch-on temperature difference heat exchange

Adjustment range: 1.0 ... 50.0 K

Factory setting: 6.0 K

ΔT_{off} heat exch.

4.0 K

0.5 49.5

ΔT_{off} heat exch.

Switch-off temperature difference heat exchange

Adjustment range: 0.5 ... 49.5 K

Factory setting: 4.0 K

T_{max} sink

60 °C

30 95

T_{max} sink

Maximum temperature heat sink

Adjustment range: 30 ... 95 °C

Factory setting: 60 °C

T_{min} source

45 °C

30

95

T_{min} source

Minimum temperature heat source

Adjustment range: 30 ... 95 °C

Factory setting: 45 °C

The heat exchange function can be used for transferring heat from a heat source to a heat sink.

The allocated relay is energised when all switch-on conditions are fulfilled:

- the temperature difference between the allocated sensors has exceeded the switch-on temperature difference
- the temperature at the heat source sensor has exceeded the minimum temperature
- the temperature at the heat sink sensor has fallen below the maximum temperature

The hystereses for **T_{max} sink** and **T_{min} source** are fixed values.

Blocking protection

(adjustable in the **Installer** menu)

Blocking protection

- No
 Yes

Blocking protection

Blocking protection function

Selection: Yes, No

Factory setting: No



BP start

Starting time blocking protection

Adjustment range: 00:00... 23:59

Factory setting: 19:00

In order to protect the pumps against blocking after standstill, the controller is equipped with a blocking protection function. This function switches on the relays one after another every day at the adjusted starting time for 10 s at 100%.



Note:

The blocking protection function is only available, if the mixer option is deactivated.

Antifreeze function

(adjustable in the **Installer** menu)



Antifreeze function

Selection: Yes, No

Factory setting: No

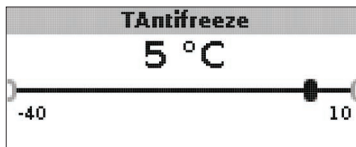

Antifreeze temperature

Adjustment range: -40... +10 °C

Factory setting: +5 °C

Antifreeze option

The antifreeze option of the loading circuit can be used to temporarily activate an inactive loading circuit during sudden temperature drops in order to protect it from frost damage.

When the antifreeze option is activated, the temperature at the reference sensor S1 is monitored. If the temperature falls below the adjusted antifreeze temperature, the loading circuit will be operated until the temperature exceeds the antifreeze temperature by the hysteresis of 1 K (fixed value).

Manual mode / Relay

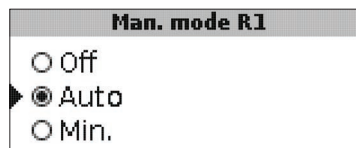
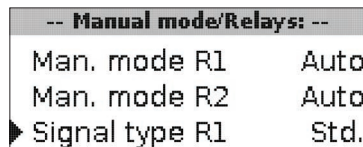

Manual mode R1 / R2 / PWM

Selection: Off, Auto, Min., Max.

Factory setting: Auto

The adjustment channels **Manual mode** can be used for selecting the mode of the relays.

- Off
- Auto
- Min. (minimum speed)
- Max. (maximum speed)

Signal type R1

- Std.
- PWM

Signal type R1/R2/PWM

Selection: Std., PWM

Factory setting: Std.

The adjustment channels **Signal type** can be used for selecting the signal type of the relays for speed control.

- Std. = Adjustment for standard pumps
- PWM = PWM signal for high-efficiency pumps

When the **Signal type** is set to PWM, the channel **Profile** appears.

Profile

- Solar
- Heating

Profile

Selection: Solar, Heating

Factory setting: Solar

In the Profile channel, PWM profiles for solar or heating pumps can be selected.

- Solar = Solar pump
- Heating = Heating pump

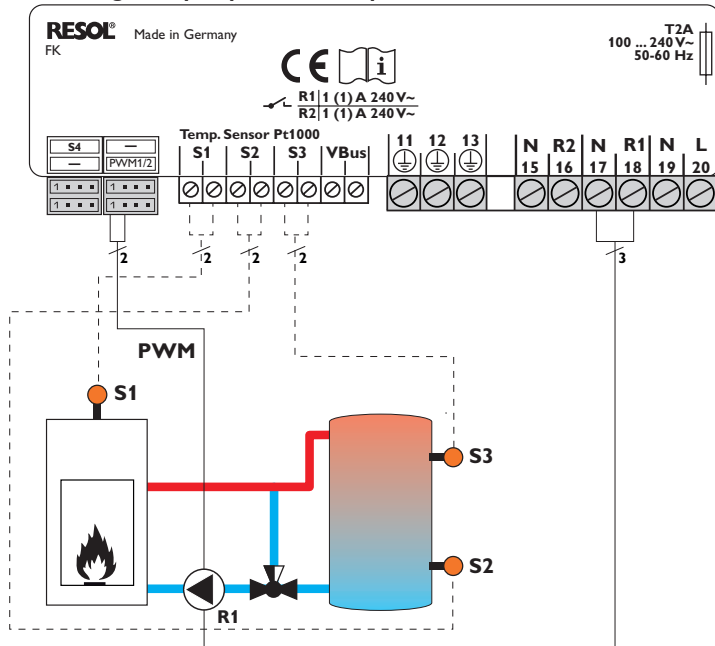
Connecting a HE pump with PWM speed control

If the signal type PWM has been selected, speed control will not take place via the relay. A separate connection for the PWM signal will have to be made (see figure).

**Note:**

HE pumps that do not require a PWM speed signal are to be connected to the relay only.

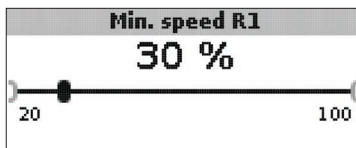

Min. speed R1/R2/PWM

Adjustment range: 20 ... 100 %

Factory setting: 100 % (PWM = 30 %)

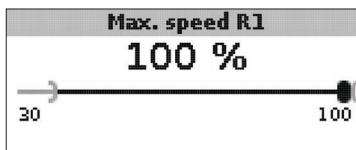

Max. speed R1/R2/PWM

Adjustment range: 20 ... 100 %

Factory setting: 100 %

The adjustment channels **Min. speed** and **Max. speed** are used for limiting the minimum and the maximum speed of the circulating pump to the target temperature.

General

In the **General** menu the menu language, temperature unit, time and date can be adjusted. Normally, these settings have been made during commissioning. They can be subsequently changed in this menu.



Language

Language selection

Selection: Deutsch, English, Français, Italiano, Español

Factory setting: German

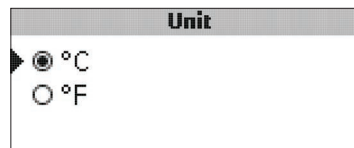

Unit

Temperature unit

Selection: °C, °F

Factory setting: °C



Time

Adjustment range: 00:00 ... 23:59

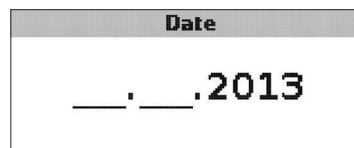

Date

Adjustment range: 01.01.2001 ... 31.12.2099

In the **General** menu, the version number and the software number are additionally displayed.

The **Installer** menu will only be visible if the installer code (see chap. 7) has been entered.

The following adjustment channels and options are described along with the corresponding functions:

ΔTset SFB / boiler

Set temperature difference SFB/boiler; speed control SFB/boiler pump, see page 19.

Rise

Rise value, speed control SFB/boiler pump, see page 19.

ΔTmin SFB / boiler

Temperature difference SFB/boiler minimum limitation, see page 18.

ΔTmax store

Hysteresis maximum store temperature, see page 20.

ΔTmin SFB / boiler

Temperature difference SFB/boiler maximum limitation, see page 20.

Interval

Interval mixer control, see page 22.

Antifreeze

Antifreeze function, see page 25.

TAntifreeze

Antifreeze temperature, see page 25.

Blocking protection

Blocking protection, see page 24.

Start BP

Starting time blocking protection, see page 25.



Installer

Selection: Yes, No

Factory setting: No

If the installer code has been entered, e. g. the installer option will be displayed. If the installer option is activated, the installer code will be permanently active. If the installer option is not activated, the controller will jump to the customer code 0000 after 4 min.

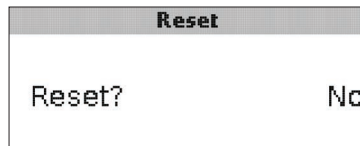

Reset

Selection: Yes, No

Factory setting: No

By means of the reset function, all adjustments can be set back to their factory settings.

➔ In order to carry out a reset, press button 3

All adjustments that have previously been made will be lost! For this reason, a security enquiry will appear after the reset function has been selected.

Only confirm the security enquiry if you are sure you want to set back all adjustment to the factory setting.

➔ In order to confirm the security enquiry, press button 3.



Note:

After a reset, the commissioning menu will start again (see page 13).

7 User code

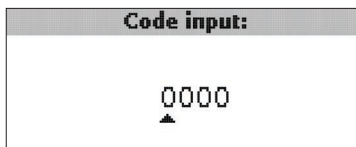

In the **User code** menu, a user code can be entered. Each number of the 4-digit code must be individually adjusted and confirmed. After the last digit has been confirmed, the menu automatically jumps to the superior menu level.

To access the menu areas of the installer level, the installer user code must be entered:

Installer code: 0262

If the installer code has been entered, the e. g. installer option will be displayed. If the installer option is activated, the installer code will be permanently active. If the installer option is not activated, the controller will jump to the customer code 0000 after 4 min.

For safety reasons, the user code should generally be set to the customer code before the controller is handed to the customer!

Customer user code: 0000

8 Menu structure

The controller is operated and controlled via the menu. During normal operation, the system screen is displayed.



Note:

The displayed values and options depend on the functions and only appear if these are available for the adjusted system parameters.

Display	Description
Measured values:	
Tmin SFB / boiler	Temperature SFB / boiler
Store base	Temperature store base
Store top	Temperature store top
Sensor 4	Temperature at sensor 4
SFB / boiler flow	SFB / boiler flow temperature
SFB / boiler return	SFB / boiler return temperature
Heating return	Heating circuit return temperature
Store 2	Temperature store 2
Pump SFB / boiler	Speed SFB / boiler
Mixer open	Operating state relay 1
Mixer closed	Operating state relay 2
Store loading pump	Speed store loading pump
Return valve	Operating state relay 2
Time	Current time
Date	Current date
Balances:	
Max. SFB/boiler	Maximum temperature SFB / boiler
Max. store base	Maximum temperature store base
Max. store top	Maximum temperature store top
Max. SFB/boiler flow	Maximum temperature SFB / boiler flow
Max. SFB/boiler return	Maximum temperature SFB / boiler return
Max. HC ret	Maximum temperature heating circuit return
Max. store 2	Maximum temperature store 2
Oper. hours R1	Operating hours relay 1
Oper. hours R2	Operating hours relay 2
Operating days	Operating days since commissioning

Display	Description	Adjustment range	Factory setting
Adjustment values			
System	System selection	1 ... 8	1
Tmin SFB / boiler	Boiler minimum temperature	10 ... 80 °C	60 °C
ΔTon SFB / boiler	Switch-on temperature difference SFB / boiler	1.0 ... 25.0K	6.0K
ΔToff SFB / boiler	Switch-off temperature difference SFB / boiler	0.5 ... 24.5K	4.0K
Ref. sensor Store	Selection reference sensor store loading	S2, S3	S2
Tmax store	Maximum store temperature	30 ... 95 °C	90 °C
Max. sensor	Selection reference sensor store maximum limitation	S2, S3	S3
Temerg SFB / boiler	Emergency temperature SFB / boiler	80 ... 105 °C	95 °C
Target temperature	Target temperature	30 ... 85 °C	60 °C
Targ. temp. sensor	Selection reference sensor target temperature	S1, S4	S1
ΔTon RPH	Switch-on temperature difference SFB / boiler	1.0 ... 25.0K	6.0K
ΔToff RPH	Switch-off temperature difference SFB / boiler	0.5 ... 24.5K	4.0K
Tmin ST RPH	Switch-on temperature return preheating store	10 ... 80 °C	60 °C
Tmin RPH	Switch-on temperature return preheating	10 ... 80 °C	30 °C
RPH sensor	Selection reference sensor return preheating	S2, S3	S3
Therm. on	Thermostat function switch-on temperature	0 ... 95 °C	40 °C
Therm. off	Thermostat function switch-off temperature	0 ... 95 °C	45 °C
Switch-on time 1	Thermostat function switch-on time 1	00:00 ... 23:59	06:00
Switch-off time 1	Thermostat function switch-off time 1	00:00 ... 23:59	07:00
Switch-on time 2	Thermostat function switch-on time 2	00:00 ... 23:59	12:00
Switch-off time 2	Thermostat function switch-off time 2	00:00 ... 23:59	13:00
Switch-on time 3	Thermostat function switch-on time 3	00:00 ... 23:59	18:00
Switch-off time 3	Thermostat function switch-off time 3	00:00 ... 23:59	20:00
ΔTon heat exch.	Switch-on temperature difference heat exchange	1.0 ... 50.0K	6.0K
ΔToff heat exch.	Switch-off temperature difference heat exchange	0.5 ... 49.5K	4.0K
Tmax sink	Maximum temperature heat sink	30 ... 95 °C	60 °C
Tmin source	Minimum temperature heat source	30 ... 95 °C	45 °C
Options:			
Mixer	Mixer option for the return mixing function	Yes, No	No
Target temperature	Target temperature option for speed control of the SFB / boiler pump	Yes, No	No
Manual mode / Relay:			
Manual mode R1	Manual mode relay 1	Off, Auto, Min., Max.	Auto
Manual mode R2	Manual mode relay 2	Off, Auto, Min., Max.	Auto
Manual mode PWM	Manual mode PWM	Off, Auto, Min., Max.	Auto
Signal type PWM	Speed control signal PWM	PWM	PWM

Display	Description	Adjustment range	Factory setting
Profile	PWM speed control signal profile	Solar, Heating	Solar
Min speed PWM	Minimum speed PWM	20 ... 100 %	30 %
Max. speed PWM	Minimum speed PWM	20 ... 100 %	100 %
Signal type R1	Speed control signal relay 1	Std., PWM	Std.
Profile	PWM speed control signal profile relay 1	Solar, Heating	Solar
Min speed R1	Minimum speed relay 1	20 ... 100 %	100 % (PWM=30 %)
Max. speed R1	Maximum speed relay 1	20 ... 100 %	100 %
Signal type R2	Speed control signal relay 2	Std., PWM	Std.
Profile	PWM speed control signal profile relay 2	Solar, Heating	Solar
Min speed R2	Minimum speed relay 2	20 ... 100 %	100 % (PWM=30 %)
Max. speed R2	Maximum speed relay 2	20 ... 100 %	100 %
General:			
Language	Language selection	Deutsch, English, Français, Italiano, Español	Deutsch
Unit	Selection temperature unit	°C, °F	°C
Time	Time		
Date	Date		
Version	Version number		
Software	Software version		
Installer:			
ΔTset SFB / boiler	Set temperature difference SFB / boiler	0.5 ... 50.0K	10.0K
Rise	Rise speed control relay 1	0.0 ... 50.0K	1.0K
Rise 2	Rise speed control relay 2	0.0 ... 50.0 K	1.0K
ΔTmin SFB / boiler	Hysteresis SFB / boiler minimum limitation	3.0 ... 15.0K	5.0K
ΔTmax store	Hysteresis maximum store temperature	1.0 ... 25.0K	2.0K
ΔTmax SFB / boiler	Hysteresis SFB / boiler maximum limitation	1.0 ... 25.0K	5.0K
Interval	Interval mixer control	1 ... 20 s	4 s
Frost protection	Antifreeze function	Yes, No	No
TAntifreeze	Antifreeze temperature	-40 ... +10 °C	+5 °C
Blocking protection	Blocking protection function	Yes, No	No
Start BP	Blocking protection starting time	00:00 ... 23:59	19:00
Installer	Installer option	Yes, No	No
Reset	Reset to factory settings	Yes, No	No
User code:			
Code	User code	0000 ... 9999	0000

9 Troubleshooting

In the case of a sensor fault, an error code (888 or -888) instead of a temperature is displayed in the sensor display channel. Furthermore, the whole display starts flashing



The display is permanently off.

If the display is off, check the power supply of the controller: Is it disconnected?

no

yes

The fuse of the controller could be blown. The fuse holder (which holds the spare fuse) becomes accessible when the cover is removed. The fuse can then be replaced.

Check the supply line and reconnect it.



Note:

For answers to frequently asked questions (FAQ) see www.resol.com.

The system overview shows an error code (888 or -888) instead of a measured value.

Sensor fault. An error code instead of a temperature is shown on the sensor display channel.

888

- 888

Cable is broken.
Check the cable.

Short circuit.
Check the cable.

Disconnected Pt1000 temperature sensors can be checked with an ohmmeter. Please check the resistance values correspond with the table.

°C	Ω	°C	Ω
-10	961	55	1213
-5	980	60	1232
0	1000	65	1252
5	1019	70	1271
10	1039	75	1290
15	1058	80	1309
20	1078	85	1328
25	1097	90	1347
30	1117	95	1366
35	1136	100	1385
40	1155	105	1404
45	1175	110	1423
50	1194	115	1442

Resistance values of Pt1000 sensors



Temperature sensors

The product range includes high-precision platinum temperature sensors, flatscrew sensors, outdoor temperature sensors, indoor temperature sensors, cylindrical clip-on sensors, also as complete sensors with immersion sleeve.

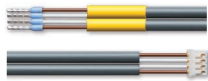

Sensor adapter cable / PWM connection cable

The connection cable can be used as a sensor adapter cable for the connection to a JST connector or as a PWM adapter cable.



VBus®/USB & VBus®/LAN interface adapters

The VBus®/USB interface adapter is the interface between the controller and a personal computer. With its standard mini-USB port it enables a fast transmission of system data for processing, visualising and archiving data via the VBus®. The RESOL ServiceCenter software is included.

The VBus®/LAN interface adapter is designed for the direct connection of the controller to a PC or router. It enables easy access to the controller via the local network of the owner. Thus, controller access and data charting can be effected from every workstation of the network. The VBus®/LAN interface adapter is suitable for all controllers equipped with a RESOL VBus®. The RESOL ServiceCenter software is included.



AM1 Alarm module

The AM1 Alarm Module is designed to signal system failures. It is to be connected to the VBus® of the controller and issues an optical signal via the red LED if a failure has occurred. The AM1 also has a relay output, which can e. g. be connected to a building management system (BMS). Thus, a collective error message can be issued in the case of a system failure. Depending on the controller and the sensors connected, different fault conditions can be signalled, e. g. sensor failures, excess or negative system pressure as well as errors in the flow rate, such as a dry run of the pump.

The AM1 Alarm module ensures that occurring failures can be immediately recognised and repaired, even if the system and the controller are difficult to access or located in a remote place. Thus, the reliability and the stable yield of the system are ensured.



DL2 Datalogger

This additional module enables the acquisition and storage of large amounts of data (such as measuring and balance values of the solar system) over a long period of time. The DL2 can be configured and read-out with a standard Internet browser via its integrated webinterface. For transmission of the data stored in the internal memory of the DL2 to a PC, an SD card can be used. It can be connected directly to a PC or router for remote access and thus enables comfortable system monitoring for yield monitoring or for diagnostics of faults.



DL3 Datalogger

Be it solar thermal, heating or DHW heat exchange controllers – with the DL3 you can easily and conveniently log system data of up to 6 RESOL controllers. Get a comprehensive overview of all controllers connected with the large full graphic display. Transfer data with an SD memory card, or use the LAN interface to view and process data on your PC.

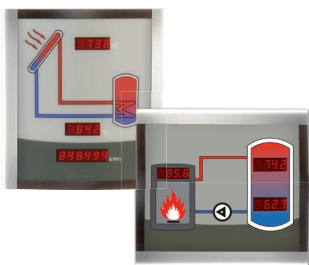

SD3 / SDFK Smart Display

The RESOL SD3 and SDFK Smart Displays are used for visualising data issued by the controller. The SD3 Smart Display indicates the collector temperature, the store temperature and the energy yield of the solar thermal system. In the heating area, the SDFK Smart Display indicates the solid fuel boiler temperature and the bottom/top store temperatures as well as the pump status. Both Smart Displays are designed for simple connection to RESOL controllers with VBus®. An additional power supply is not required.



VBus® Touch FK

With VBus® Touch FK, you can turn your mobile devices into a RESOL remote data display for your solid fuel or biomass boiler controller.

VBus® Touch FK is suitable for all RESOL controllers with a solid fuel boiler function that are connected to the Internet via a RESOL Datalogger or Communication Module.

A		P	
Accessories.....	33	PWM speed control, connecting a HE pump.....	21
Adjustment mode.....	12	R	
Antifreeze function.....	25	Reset.....	28
B		Return preheating.....	22
Balance diagrams.....	16	S	
Balance values.....	17	Speed control.....	19
Blocking protection.....	25	Store reference sensor.....	20
Boiler maximum limitation.....	20	System overview.....	7
Boiler minimum limitation.....	18	T	
C		Target temperature control.....	19
Commissioning.....	13	Technical data.....	4
D		Thermostat function.....	23
Data communication / VBus®.....	6	U	
Differential control.....	18	User code.....	29
E			
Electrical connection.....	6		
H			
Heat exchange.....	24		
HE pump with PWM speed control, connection.....	26		
M			
Manual mode / Relay.....	26		
Maximum store temperature.....	20		
Measured values.....	16		
Menu General.....	27		
Menu Installer.....	28		
Menu overview.....	30		
Mixer.....	21		
Mounting.....	5		

Distributed by:

RESOL – Elektronische Regelungen GmbH

Heiskampstraße 10
45527 Hattingen / Germany

Tel.: +49 (0) 23 24 / 96 48 - 0

Fax: +49 (0) 23 24 / 96 48 - 755

www.resol.com

info@resol.com

Important note

The texts and drawings in this manual are correct to the best of our knowledge. As faults can never be excluded, please note:

Your own calculations and plans, under consideration of the current standards and directions should only be basis for your projects. We do not offer a guarantee for the completeness of the drawings and texts of this manual - they only represent some examples. They can only be used at your own risk. No liability is assumed for incorrect, incomplete or false information and / or the resulting damages.

Note

The design and the specifications can be changed without notice.

The illustrations may differ from the original product.

Imprint

This mounting- and operation manual including all parts is copyrighted. Another use outside the copyright requires the approval of RESOL – Elektronische Regelungen GmbH. This especially applies for copies, translations, micro films and the storage into electronic systems.

© RESOL – Elektronische Regelungen GmbH