

DeltaTherm® HC mini

RESOL®

Heating controller

Manual for the
specialised craftsman

Mounting

Connection

Operation

Troubleshooting

Application examples

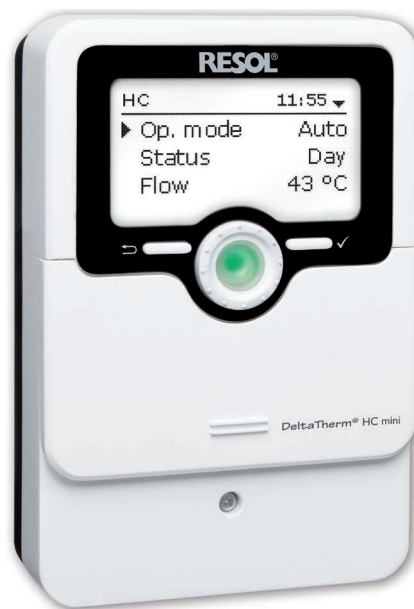

11205773



Adjust your heating via app

Thank you for buying this RESOL product.

Please read this manual carefully to get the best performance from this unit. Please keep this manual carefully.

en

Manual

www.resol.com

Safety advice

Please pay attention to the following safety advice in order to avoid danger and damage to people and property.

Instructions

Attention must be paid to the valid local standards, regulations and directives!

Information about the product

Proper usage

The controller is designed for use in heating systems in compliance with the technical data specified in this manual.

Improper use excludes all liability claims.

CE-Declaration of conformity

The product complies with the relevant directives and is therefore labelled with the CE mark. The Declaration of Conformity is available upon request, please contact RESOL.



Note:

Strong electromagnetic fields can impair the function of the device.

- Make sure the device as well as the system are not exposed to strong electromagnetic fields.

Subject to technical change. Errors excepted.

Target group

These instructions are exclusively addressed to authorised skilled personnel.

Only qualified electricians should carry out electrical works.

Initial installation must be effected by the system owner or qualified personnel named by the system owner.

Description of symbols

WARNING! Warnings are indicated with a warning triangle!



→ **They contain information on how to avoid the danger described.**

Signal words describe the danger that may occur, when it is not avoided.

- **WARNING** means that injury, possibly life-threatening injury, can occur.
- **ATTENTION** means that damage to the appliance can occur.



Note:

Notes are indicated with an information symbol.

- Arrows indicate instruction steps that should be carried out.

Disposal

- Dispose of the packaging in an environmentally sound manner.
- At the end of its working life, the product must not be disposed of as urban waste. Old appliances must be disposed of by an authorised body in an environmentally sound manner. Upon request we will take back your old appliances bought from us and guarantee an environmentally sound disposal of the devices.



DeltaTherm® HC mini Heating controller

The DeltaTherm® HC mini can control a weather-compensated heating circuit and its afterheating demand. Due to the commissioning menu and the 4 pre-configured basic systems, configuration is quick and easy.

2 microbuttons for quick access to the chimney sweeper/screed drying function and holiday mode are located underneath the slidable housing cover, the SLider.

Contents

1	Overview	4	6	Heating	20
2	Installation	5	6.1	Shared relays	20
2.1	Mounting.....	5	6.2	Heating circuit	21
2.2	Electrical connection.....	5	6.3	Screed drying.....	26
2.3	Data communication / Bus.....	6	7	Basic settings	27
2.4	MicroSD card slot.....	6	8	SD card	28
3	Operation and function	7	9	Manual mode	29
3.1	Buttons and adjustment dial.....	7	10	User code	30
3.2	Microbutton for chimney sweeper function/screed drying and holiday mode.....	7	11	In-/Outputs	30
3.3	Control lamp	7	11.1	Inputs.....	30
4	Commissioning	12	11.2	Outputs.....	31
4.1	Schemes with basic settings	13	12	Troubleshooting	33
5	Functions and options	18	13	Accessories	35
5.1	Menu structure.....	18	13.1	Sensors and measuring instruments.....	36
5.2	Status menu.....	19	13.2	VBus® accessories.....	36
5.3	Heating.....	19	13.3	Interface adapters	36
5.4	Meas./Balance values	19	14	Index	37
5.5	Messages	19			

1 Overview

- 4 pre-configured basic systems
- 4 relay outputs (incl. 1 extra-low voltage relay)
- 5 inputs for Pt1000 temperature sensors
- 5 operating modes, boiler protection, room thermostat and night correction
- Chimney sweeper function, screed drying function and holiday mode via micro-buttons
- Data logging, storing and firmware updates via MicroSD memory card
- Unit °F and °C selectable

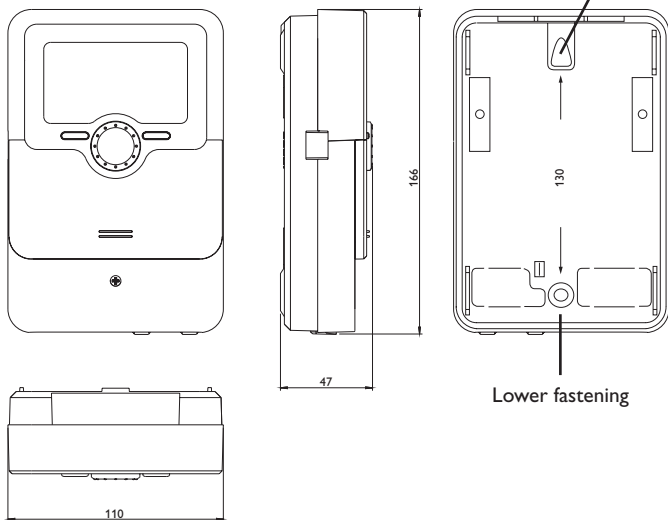

Technical data

Inputs: 5 inputs for Pt1000 temperature sensors (1 of them can be converted to Switch and one of them to RTA)

Outputs: 3 semiconductor relays, 1 potential-free extra-low voltage relay, 1 PWM output, 1 0-10V output

PWM frequency: 512 Hz

PWM voltage: 10.8 V

Switching capacity:

1 (1) A 240 V~ (semiconductor relay)

1 (1) A 30 V== (potential-free relay)

Total switching capacity: 3 A 240 V~

Power supply: 100 ... 240 V~ (50 ... 60 Hz)

Supply connection: type Y attachment

Standby: 0.66 W

Temperature controls class: III

Energy efficiency contribution: 1,5 %

Mode of operation: type 1.B.C.Y action

Rated impulse voltage: 2.5 kV

Data interface: VBus®, MicroSD card slot

VBus® current supply: 60 mA

Functions: weather-compensated heating circuit control, afterheating, room thermostat, chimney sweeper function, screed drying function, holiday mode

Housing: plastic, PC-ABS and PMMA

Mounting: wall mounting, also suitable for mounting into patch panels

Indication/Display: full graphic display, control lamp (Lightwheel®)

Operation: 4 push buttons at the front and 1 Lightwheel®

Protection type: IP 20/DIN EN 60529

Protection class: I

Ambient temperature: 0 ... 40 °C

Degree of pollution: 2

Dimensions: 110x166x47 mm

2 Installation

2.1 Mounting

WARNING! Electric shock!



Upon opening the housing, live parts are exposed!

→ **Always disconnect the controller from power supply before opening the housing!**



Note:

Strong electromagnetic fields can impair the function of the device.

→ Make sure the device as well as the system are not exposed to strong electromagnetic fields.

The unit must only be located in dry interior rooms.

The controller must additionally be supplied from a double pole switch with contact gap of at least 3 mm.

Please pay attention to separate routing of sensor cables and mains cables.

In order to mount the device to the wall, carry out the following steps:

- Unscrew the crosshead screw from the cover and remove it along with the cover from the housing.
- Mark the upper fastening point on the wall. Drill and fasten the enclosed wall plug and screw leaving the head protruding.
- Hang the housing from the upper fastening point and mark the lower fastening point (centres 130 mm).
- Insert lower wall plug.
- Fasten the housing to the wall with the lower fastening screw and tighten.
- Carry out the electrical wiring in accordance with the terminal allocation (see page 5).
- Put the cover on the housing.
- Attach with the fastening screw.

2.2 Electrical connection

WARNING! Electric shock!



Upon opening the housing, live parts are exposed!

→ **Always disconnect the controller from power supply before opening the housing!**

ATTENTION! ESD damage!



Electrostatic discharge can lead to damage to electronic components!

→ **Take care to discharge properly before touching the inside of the device! To do so, touch a grounded surface such as a radiator or tap!**



Note:

Connecting the device to the power supply must always be the last step of the installation!



Note:

The pump speed must be set to 100% when auxiliary relays or valves are connected.



Note:

It must be possible to disconnect the device from the mains at any time.

- Install the mains plug such that it is accessible at any time.
- If this is not possible, install a switch that can be accessed.

Do not use the device if it is visibly damaged!

Depending on the product version, cables are already connected to the device. If that is not the case, please proceed as follows:

The controller is equipped with 4 **relays** in total to which loads such as pumps, valves, etc. can be connected:

Relays 1 ... 3 are semiconductor relays, designed for pump speed control:

Conductor R1 ... R3

Neutral conductor N (common terminal block)

Protective earth conductor \oplus (common terminal block)

Relay 4 is a potential-free extra-low voltage relay:

Connections to the R4 terminals can be made with either polarity.

Connect the **temperature sensors** (S1 to S5) to the terminals S1 ... S5 and GND (either polarity).

The terminals marked **PWM/0-10V** are control outputs for high-efficiency pumps. The controller is supplied with power via a mains cable. The power supply of the device must be 100 ... 240 V~ (50 ... 60 Hz).

The **mains connection** is at the terminals:

Neutral conductor N

Conductor L

Protective earth conductor \oplus (common terminal block)



Note

For more details about the commissioning procedure see page 12.

2.3 Data communication/Bus

The controller is equipped with the **RESOL VBus®** for data transfer and energy supply to external modules. The connection is to be carried out at the terminals marked **VBus** (either polarity).

One or more **RESOL VBus®** modules can be connected via this data bus, such as:

- RESOL DL2 Datalogger
- RESOL DL3 Datalogger
- RESOL KM1 Communication module

Furthermore, the controller can be connected to a PC or integrated into a network via the RESOL VBus®/USB or VBus®/LAN interface adapter (not included). Different solutions for visualisation and remote parameterisation are available on the RESOL website www.resol.com.

On the website, firmware updates are also available.



Note

More accessories on page 35.

2.4 MicroSD card slot

The controller is equipped with a MicroSD card slot.

With a MicroSD card, the following functions can be carried out:

- Store measurement and balance values onto the MicroSD card. After the transfer to a computer, the values can be opened and visualised, e. g. in a spreadsheet.
- Prepare adjustments and parameterisations on a computer and transfer them via the MicroSD card.

- Store adjustments and parameterisations on the MicroSD card and, if necessary, retrieve them from there.
- Download firmware updates from the Internet and install them on the controller via MicroSD card.

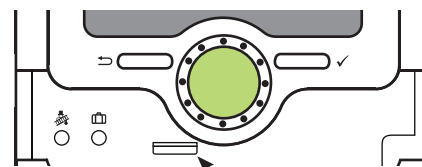

MicroSD card slot

A MicroSD card is not included, but can also be purchased at RESOL.



Note

For more information about using a MicroSD card, see page 28.

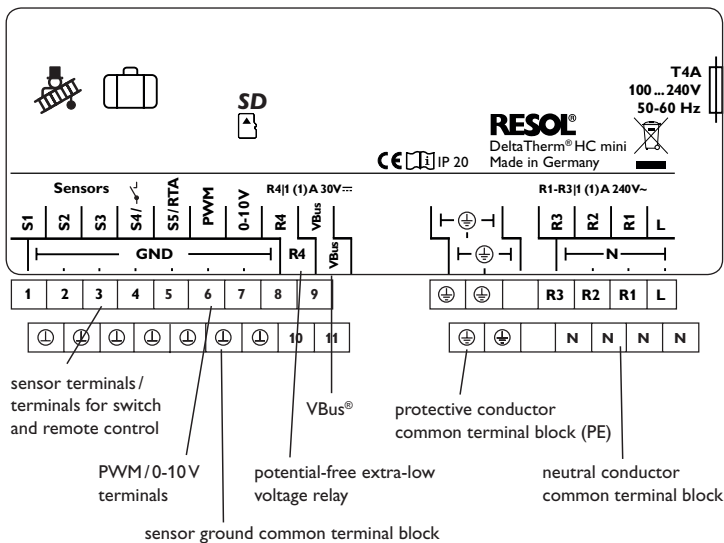

3 Operation and function

3.1 Buttons and adjustment dial

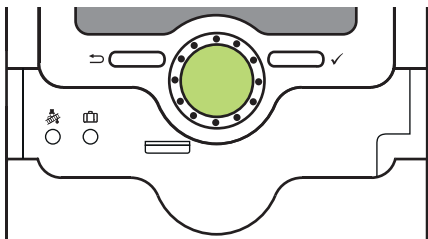

The controller is operated via 2 buttons and 1 adjustment dial (Lightwheel®) below the display:



Left button (←) - escape button for changing into the previous menu/changing to the home screen (Status Heating circuit), if the button is pressed for 2 s



Right button (✓) - confirming/selecting

Lightwheel® - scrolling upwards/scrolling downwards, increasing adjustment values/reducing adjustment values

3.2 Microbutton for chimney sweeper function/screed drying and holiday mode

The controller is equipped with two microbuttons for quick access to the holiday mode and the chimney sweeper function/screed drying. The microbuttons are located underneath the slidable housing cover, the **SLider**:





Microbutton : The chimney sweeper or screed drying function can be triggered with the microbutton . The chimney sweeper function is activated by default. In order to activate the screed drying function, the chimney sweeper function must be deactivated (see page 24). In order to trigger the chimney sweeper or screed drying function, press and hold down the microbutton  for 5 s.

Microbutton : The microbutton  is used for activating the holiday mode. If the microbutton is pressed and held down for approx. 3 s, the adjustment channel **Days of absence** appears, allowing to enter the number of days for an absence. If the parameter is set to a value higher than 0, the holiday mode becomes active and the days will be counted backwards at 00:00. If the value is set to 0, the holiday

mode is deactivated.

3.3 Control lamp

The controller is equipped with a multicolour LED in the centre of the Lightwheel®, indicating the following states:

Colour	Permanently shown	Flashing
	Everything OK	Manual mode on
	Screed drying cancelled	Sensor line break, sensor short circuit, initialisation
	Holiday mode active	Chimney sweeper function / screed drying active
		Manual mode off

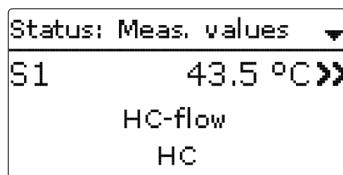

If the symbol » is shown behind a menu item, pressing the right button (✓) will open a new submenu.

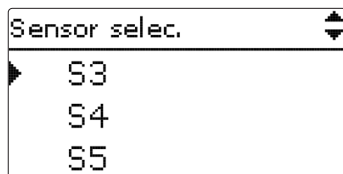

Values and adjustments can be changed in different ways:

Numeric values can be adjusted by means of a slide bar. The minimum value is indicated to the left, the maximum value to the right. The large number above the slide bar indicates the current adjustment. By turning the Lightwheel®, the upper slide bar can be moved to the left or to the right.

Only after the adjustment has been confirmed by pressing the right button (✓) will the number below the slide bar indicate the new value. The new value will be saved if it is confirmed by pressing the right button (✓) again.

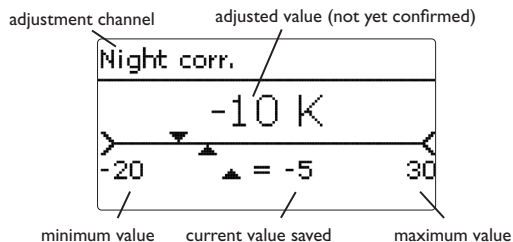

When 2 values are locked against each other, they will display a reduced adjustment range depending on the adjustment of the respective other value.

In this case, the active area of the slide bar is shortened, the inactive area is indicated as a dotted line. The indication of the minimum and maximum values will adapt to the reduction.

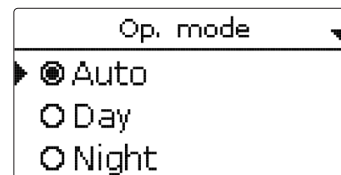

If only one item of several can be selected, they will be indicated with radio buttons. When one item has been selected, the radio button in front of it is filled.

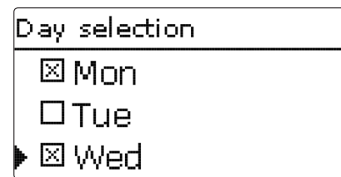

If more than one item of several can be selected, they will be indicated with checkboxes. When an item has been selected, an x appears inside the checkbox.

If no button has been pressed within a couple of minutes, the adjustment is cancelled and the previous value is retained.

Adjusting the timer

When the **Timer** option is activated, a timer is indicated in which time frames for the function can be adjusted.

In the **Day selection** channel, the days of the week are available individually and as frequently selected combinations.

If more than one day or combination is selected, they will be merged into one combination for the following steps.

The last menu item after the list of days is **Continue**. If **Continue** is selected, the **Edit timer** menu opens, in which the time frames can be adjusted.

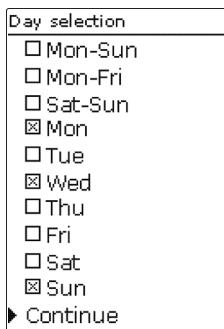
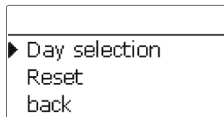

Adding a time frame:

In order to add a time frame, proceed as follows:

- ➔ Select **New time frame**.

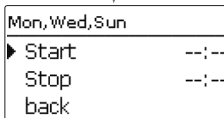
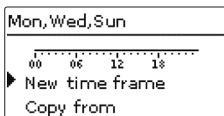

- ➔ Adjust **Start** and **Stop** for the desired time frame.

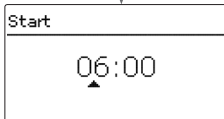

The time frames can be adjusted in steps of 5 min.

- ➔ In order to save the time frame, select **Save** and confirm the safety enquiry with **Yes**.

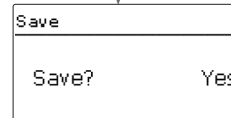
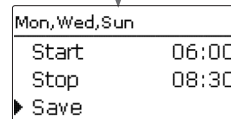
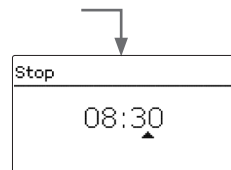

- ➔ In order to add another time frame, repeat the previous steps.

6 time frames can be adjusted per day or combination.

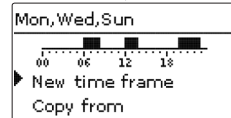
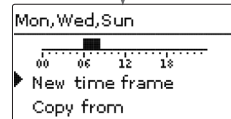

- ➔ Press the left button  in order to get back to the day selection.

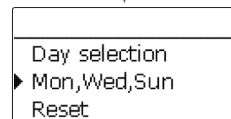

Copying a time frame:

In order to copy time frames already adjusted into another day/another combination, proceed as follows:

- ➔ Choose the day/The combination into which the time frames are to be copied and select **Copy from**.

A selection of days and/or combinations with time frames will appear.

- ➔ Select the day or combination from which the time frames are to be copied.

All time frames adjusted for the selected day or combination will be copied.

If the time frames copied are not changed, the day or combination will be added to the combination from which the time frames have been copied.

If the time frames copied are changed, the day/combination will be listed separately.

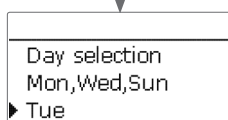
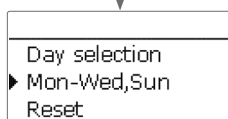
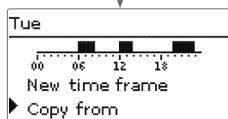
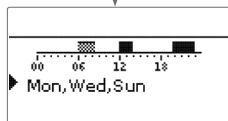
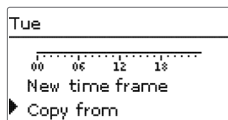

Changing a time frame:

In order to change a time frame, proceed as follows:

- ➔ Select the time frame to be changed.

- ➔ Make the desired change.

- ➔ In order to save the time frame, select **Save** and confirm the safety enquiry with **Yes**.

Removing a time frame:

In order to delete a time frame, proceed as follows:

- ➔ Select the time frame that is to be deleted.

- ➔ Select **Delete** and confirm the safety enquiry with **Yes**.

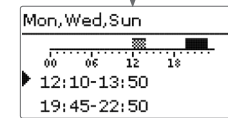
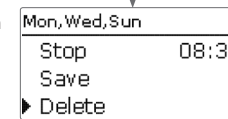
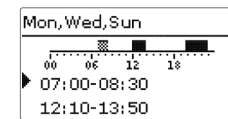
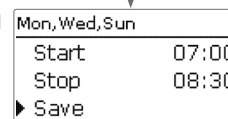
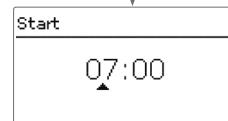
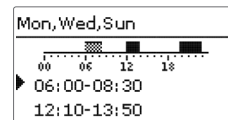

Resetting the timer:

In order to reset time frames adjusted for a certain day or combination, proceed as follows

→ Select the desired day or combination.

→ Select **Reset** and confirm the safety enquiry with **Yes**.

The selected day or combination will disappear from the list, all its time frames will be deleted

Day selection
▶ Mon,Wed,Sun
Tue

Tue
00 06 12 18
New time frame
▶ Copy from

Reset
Reset? Yes

▶ Day selection
Tue
Reset

In order to reset the whole timer, proceed as follows:

→ Select **Reset** and confirm the safety enquiry with **Yes**.

All adjustments made for the timer are deleted.

Mon,Wed,Sun
Tue
▶ Reset

Reset
Reset? Yes

Day selection
▶ Reset
back

4 Commissioning

When the hydraulic system is filled and ready for operation, connect the controller to the mains.

The controller runs an initialisation phase in which the Lightwheel® flashes red.

When the controller is commissioned or when it is reset, it will run a commissioning menu after the initialisation phase. The commissioning menu leads the user through the most important adjustment channels needed for operating the system.

Disconnecting the controller from the power supply after having run the commissioning menu will not delete adjustments that have already been carried out. After you switch on the device again, the controller will not start the commissioning menu, but normal operation after the initialisation phase.

Commissioning menu

The commissioning menu consists of the channels described in the following. In order to make an adjustment, adjust the desired value with the Lightwheel® and confirm with the right button (✓). The next channel will appear in the display.

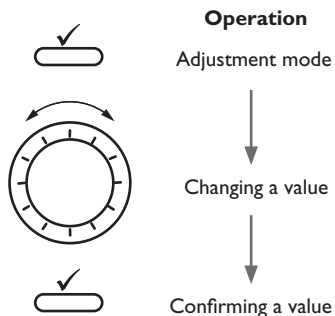

1. Language:

→ Adjust the desired menu language.

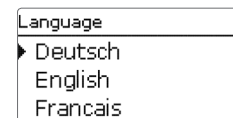

2. Temperature unit:

→ Adjust the desired temperature unit.

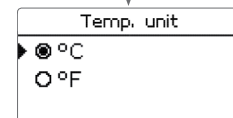

3. Daylight savings time adjustment:

→ Activate or deactivate the automatic daylight savings time adjustment.

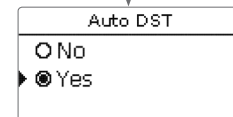

4. Time:

→ Adjust the clock time. First of all adjust the hours, then the minutes.

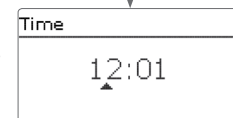

5. Date:

→ Adjust the date. First of all adjust the year, then the month and then the day.

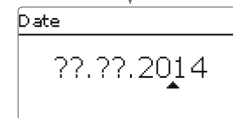

6. Scheme:

→ Adjust the desired scheme (heating circuit, demand).

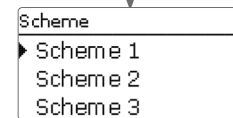

7. Completing the commissioning menu:

After the scheme has been selected, a security enquiry appears. If the safety enquiry is confirmed, the adjustments are saved.

- ➔ In order to confirm the security enquiry, press the right button (✓).
- ➔ In order to reenter the commissioning menu channels, press the left button (↶). If the security enquiry has been confirmed, the controller is ready for operation and should enable an optimum system operation.

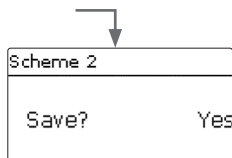

Adjusting the operating mode:

After commissioning the heating circuit will be in automatic mode. The operating mode can be changed in the status menu:

- Automatic
- Day
- Night
- Holiday
- Off



Note:

The adjustments carried out during commissioning can be changed anytime in the corresponding adjustment channel. Additional functions and options can also be activated or deactivated (see page 18).

Set the code to the customer code before handing over the controller to the customer (see page 30).

4.1 Schemes with basic settings

The controller is preprogrammed for 4 basic systems. The basic pre-adjustments have already been made.

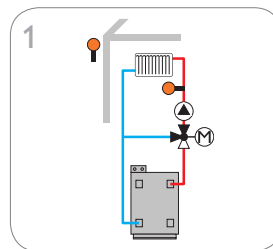

1 mixed heating circuit (see page 14)

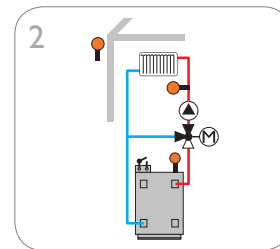

1 mixed heating circuit with afterheating (demand) (see page 15)

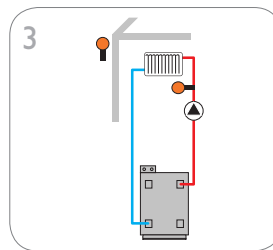

1 unmixed heating circuit (see page 16)

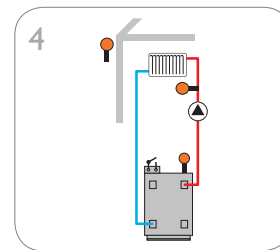

1 unmixed heating circuit with afterheating (demand) (see page 17)

Scheme 1: 1 mixed heating circuit

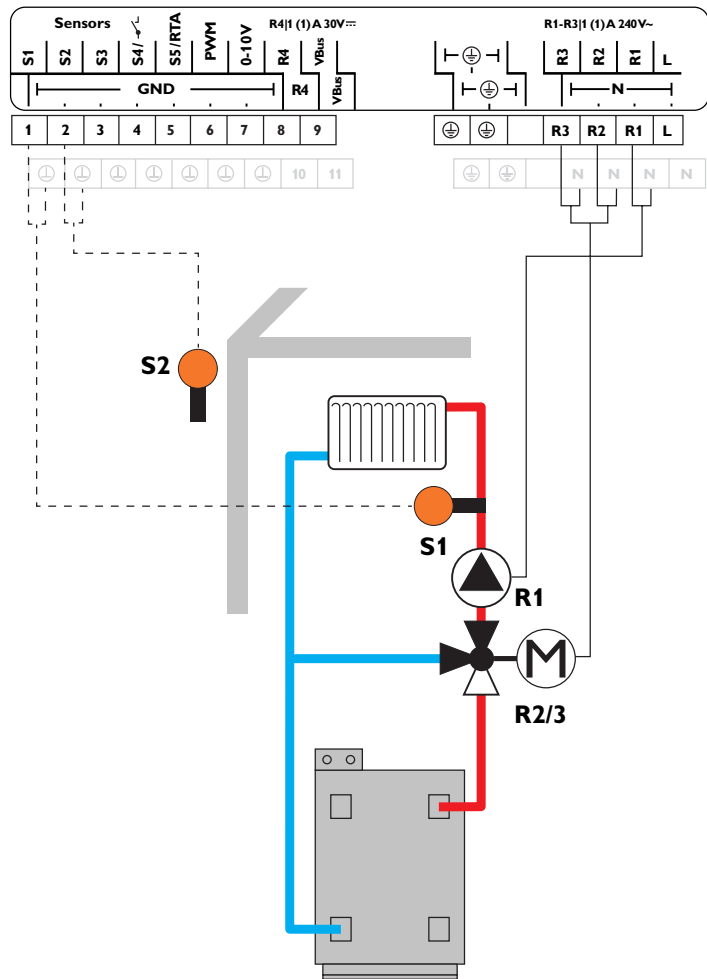

Sensors

S1	Flow HC	1/GND
S2	Outdoor	2/GND
S3	Free	3/GND
S4	Free	4/GND
S5	Free	5/GND

Relay

R1	HC pump	R1/N/PE
R2	Mixer open	R2/N/PE
R3	Mixer closed	R3/N/PE
R4	Free	8/10

By means of the flow sensor S1 and the outdoor temperature sensor S2, a mixed weather-compensated heating circuit can be controlled.

Scheme 2: 1 mixed heating circuit with afterheating (demand)

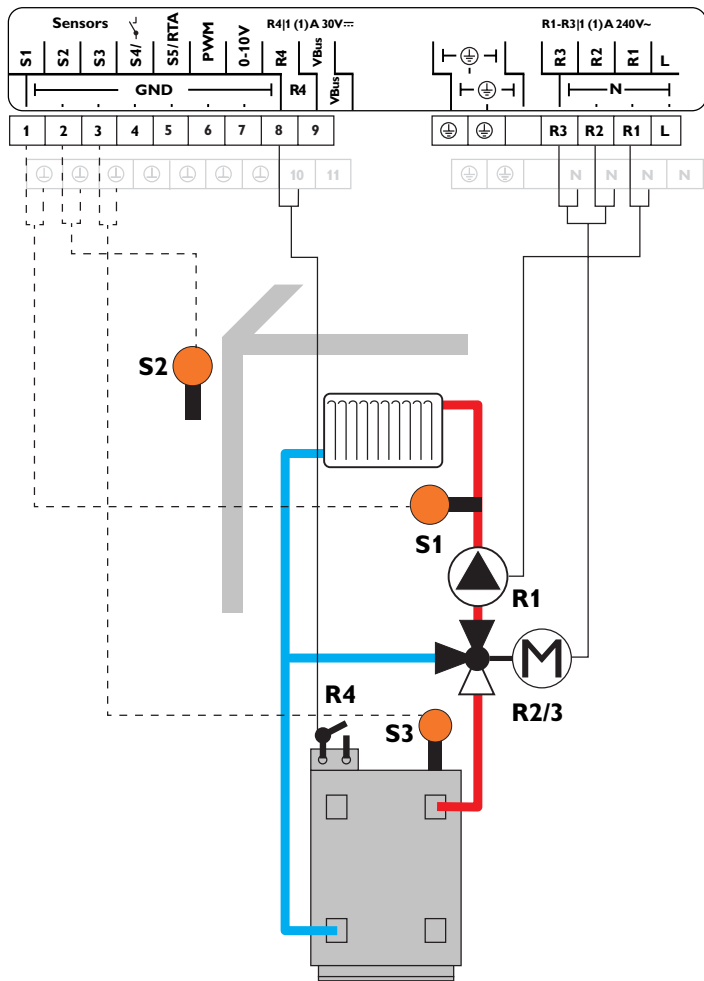

Sensors

S1	Flow HC	1/GND
S2	Outdoor	2/GND
S3	Afterheating/boiler	3/GND
S4	Free	4/GND
S5	Free	5/GND

Relay

R1	HC pump	R1/N/PE
R2	Mixer open	R2/N/PE
R3	Mixer closed	R3/N/PE
R4	Demand	8/10

By means of the flow sensor S1 and the outdoor temperature sensor S2, a mixed weather-compensated heating circuit can be controlled. Boiler demand via the potential-free relay is triggered depending on the temperature difference between the set flow temperature and the value measured at the afterheating sensor S3.

Scheme 3: 1 unmixed heating circuit

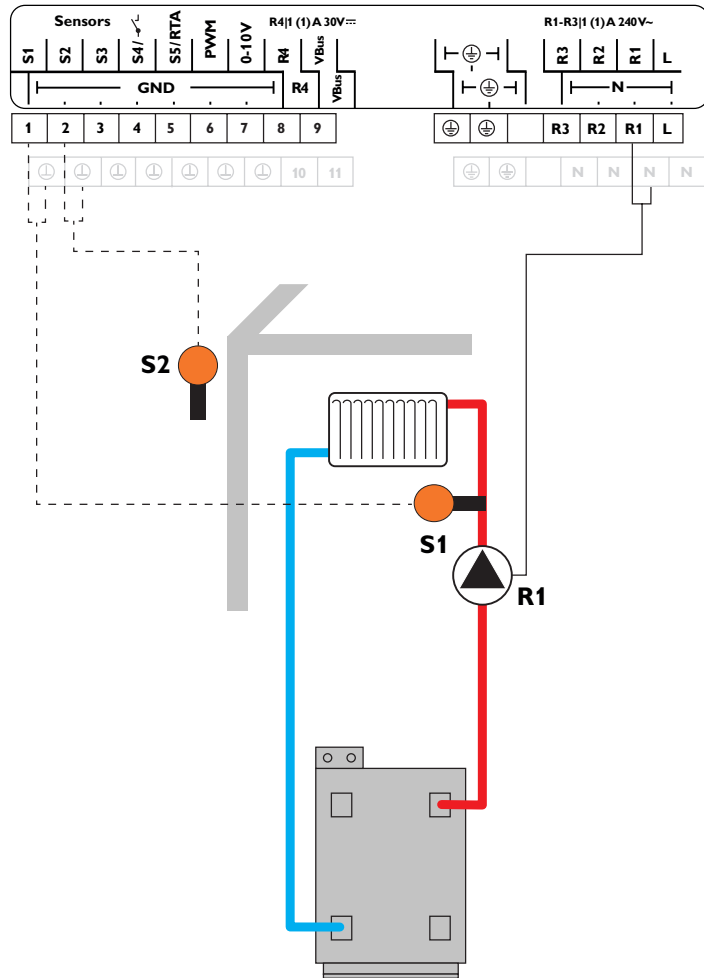

Sensors

S1	Flow HC	1/GND
S2	Outdoor	2/GND
S3	Free	3/GND
S4	Free	4/GND
S5	Free	5/GND

Relay

R1	HC pump	R1/N/PE
R2	Free	R2/N/PE
R3	Free	R3/N/PE
R4	Free	8/10

By means of the flow sensor S1 and the outdoor temperature sensor S2, an unmixed weather-compensated heating circuit can be controlled.

Scheme 4: 1 unmixed heating circuit with afterheating (demand)

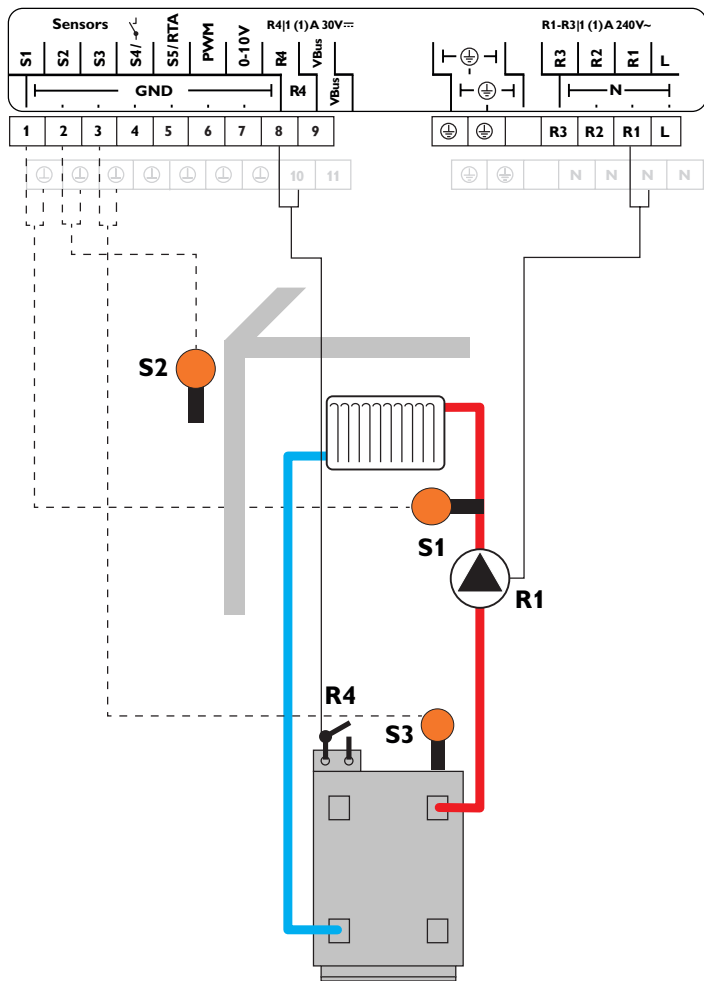

Sensors

S1	Flow HC	1/GND
S2	Outdoor	2/GND
S3	Afterheating/boiler	3/GND
S4	Free	4/GND
S5	Free	5/GND

Relay

R1	HC pump	R1/N/PE
R2	Free	R2/N/PE
R3	Free	R3/N/PE
R4	Demand	8/10

By means of the flow sensor S1 and the outdoor temperature sensor S2, an unmixed weather-compensated heating circuit can be controlled. Boiler demand via the potential-free relay is triggered depending on the temperature difference between the set flow temperature and the value measured at the afterheating sensor S3.

5 Functions and options

5.1 Menu structure

Main menu

Status

Heating

Basic settings

SD card

Manual mode

User code

In-/Outputs

Heating

Shared relays

Heating circuit

Screed drying

Basic settings

Language

Temp. unit

Auto DST

Time

...

Scheme

Factory setting

In-/Outputs

Inputs

Outputs

Heating circuit

Heating system

Heating curve

Interval

Day correction

...

TFrost

Chimney sweeper



The menu items and adjustment values selectable are variable depending on adjustments already made. The figure only shows an exemplary excerpt of the complete menu in order to visualise the menu structure.

5.2 Status menu



The status menu contains information about the current state of the heating circuits. Furthermore, measured and balance values as well as messages are indicated.

5.3 Heating

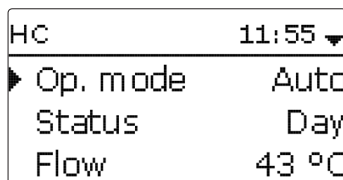

In the **Status/HC** menu, the status of the heating circuit is indicated. The status of the heating circuit is also the home screen of the controller. In this menu, the operating mode of the heating circuit can be changed:

Automatic: Automatic heating mode.

Day: Constant heating mode with the adjusted day correction.

Night: Constant heating mode with the adjusted night correction and the selected correction mode.

Holiday: Constant heating mode within an adjustable time frame with the adjusted night correction and the selected correction mode.

Off: The heating circuit is switched off. The antifreeze function of the heating circuit remains active.

5.4 Meas./Balance values

In the **Status/Meas./Balance** menu, all current measurement values as well as a range of balance values are displayed. Some of the menu items can be selected in order to enter a submenu.

Each sensor and relay is indicated with the component or function it has been allocated to. The symbol ▶ at the edge of the display next to a sensor allocated to a function, means that this sensor has several functions. Use the Lightwheel® to scroll to these functions. The sensors and relays of the controller are listed in numerical order.

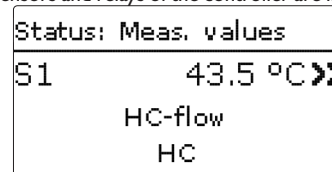

When a line with a measurement value is selected, another submenu will open.

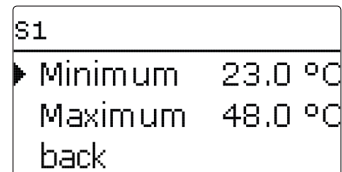

If, for example, S1 is selected, a submenu indicating the minimum and maximum values will open.

5.5 Messages



In the **Status/Messages** menu, error and warning messages which have not been acknowledged are indicated.

During normal operation, the message **Everything OK** is indicated.

A short circuit (**short-circuit**) or line break (**break**) in a sensor line is indicated as **!Sensor fault**.

6 Heating

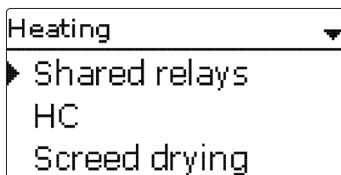

In this menu, all adjustments for the heating circuit can be made. Additionally, the screed drying function can be activated and adjusted.

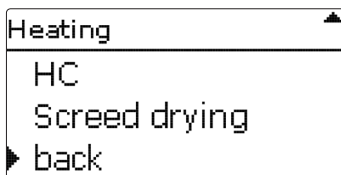

6.1 Shared relays

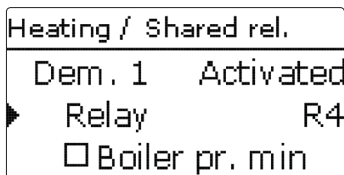

In this menu, 1 shared relay can be activated and adjusted. Further options such as a minimum and a maximum limitation for boiler protection are also available. The shared relay will be available for selection under Virtual in the relay allocation channel of the Heating circuit menu.



Note:

Activate and adjust the shared relay first. It will then be available in the heating circuit.

Demand

For demand of a boiler, for example, the shared relay **Demand 1** is available. The options Boiler protection min and Boiler protection max can be activated for the shared relay, allowing temperature-dependent control of the boiler demand. For this purpose, a boiler sensor is required.

The **Boiler pr. min** option is used for protecting an older type boiler against cooling. If the temperature falls below the adjusted minimum temperature, the allocated relay is energised until the minimum temperature is exceeded by 2 K.

The **Boiler pr. max** option is used for protecting an older type boiler against overheating. If the adjusted maximum temperature is exceeded, the allocated relay is switched off until the temperature falls by 2 K below the maximum temperature.

Heating/Shared relays

Adjustment channel	Description	Adjustment range/selection	Factory setting
Dem. 1	Boiler demand option	Activated, Deactivated	Deactivated
Relay	Relay selection	system dependent	system dependent
Boiler pr. min	Shared relay option for boiler protection min	Yes, No	No
Tmin	Boiler minimum temperature	10 ... 90 °C	55 °C
Boiler pr. max	Shared relay option for boiler protection max	Yes, No	No
Tmax	Boiler maximum temperature	20 ... 95 °C	90 °C
Sensor Boiler	Boiler sensor selection	system dependent	system dependent

6.2 Heating circuit

The controller has one heating circuit. The following heating circuit variants are possible:

- 1 mixed weather-compensated heating circuit
- 1 unmixed weather-compensated heating circuit
- 1 mixed constant heating circuit

HC	
▶ HC pump	R1
Mixer open	R2
Mixer closed	R3

The heating system **Constant** is only available in a mixed heating circuit. An outdoor temperature sensor cannot be allocated.

HC	
▶ Heat. sys. Constant	
Sensor Flow	S1
Set temp.	25 °C

The heating system **Constant** aims to keep the set flow temperature to a constant value which can be adjusted by means of the parameter **Set temperature**.

If the heating system **Curve** is selected, the controller calculates a set flow temperature by means of the outdoor temperature and the selected **Heating curve**. In both cases, the dial setting of the remote control and the controller day correction or night correction are added.

Heating circ.	
▶ Heating curve	1.0
Interval	4
Day correction	0 K

Heating system Constant:

Set flow temperature = set temperature + remote control + day correction or night correction

Heating system Curve:

Set flow temperature = heating curve temperature + remote control + day correction or night correction

The calculated set flow temperature is limited by the adjusted values of the parameters **set flow temperature** and **flow minimum temperature**.

Flow maximum temperature \geq set flow temperature \geq flow minimum temperature
If the measured flow temperature deviates from the set flow temperature, the mixer will be activated in order to adjust the flow temperature correspondingly.

The mixer runtime can be adjusted with the parameter **Interval**.

The parameter **Pump off** is used for switching off the heating circuit pump, if the adjusted value of the flow maximum temperature is exceeded by 5 K.

Heating circ.	
Tflowmax	50 °C
▶ <input type="checkbox"/> Pump off	
Tflowmin	20 °C

If the outdoor temperature sensor is defective, an error message will be indicated. For the duration of this condition, the maximum flow temperature -5 K is assumed as the set flow temperature.

The **Remote control** allows manual adjustment of the heating curve (± 15 K). Furthermore, the heating circuit can be switched off or a rapid heating can be carried out by means of the remote control.

Heating circuit switched off means that the heating circuit pump is switched off and the mixer closed. The flow temperature is boosted to maximum for rapid heating when the remote control is set to rapid heating.

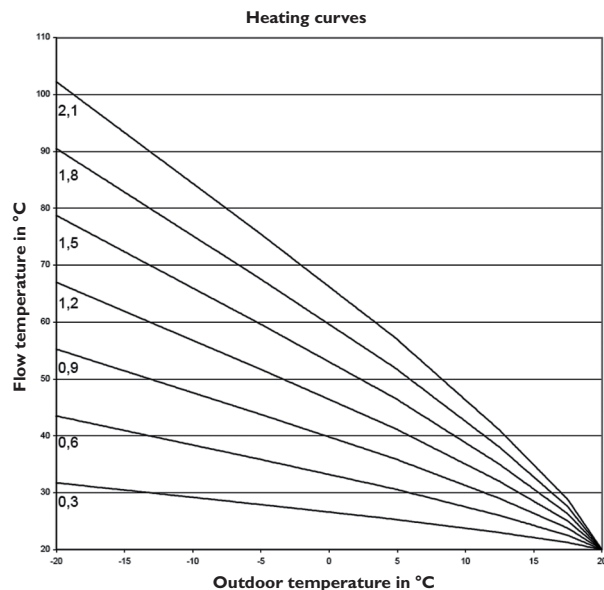

Heating circ.	
▶ TSummer	20 °C
Daytime on	00:00
Daytime off	00:00

The automatic summer mode becomes active when the outdoor temperature exceeds the adjusted summer temperature **TSummer**. This can be limited to a daytime frame with the parameters **Daytime on** and **Daytime off**. Outside the adjusted time frame, the lower temperature **TNight** is used in summer mode. In summer mode, the heating circuit is switched off.

Heating circ.	
Daytime on	09:00
Daytime off	19:00
▶ TNight	14 °C
HC	
Day corr.	-0 K
Night corr.	-5 K
▶ <input type="checkbox"/> Timer	

With the **Timer**, the day/night operation can be adjusted. During day phases, the set flow temperature is increased by the adjusted **Day correction** value, during night phases it is decreased by the **Night correction** value (night setback).

HC	
▶ Night corr.	-5 K
<input type="checkbox"/> Timer	
Tflowmax	50 °C

Heating circ.	
<input checked="" type="checkbox"/> Timer	
▶ Mode Day / Night	
Timer HC	➤➤

The parameter **Mode** is used for selecting between the following correction modes:
Day / night: A reduced set flow temperature (night correction) is used during night operation.

Day / off: The heating circuit and the optionally activated afterheating are switched off during night operation.

Room / off: The heating circuit and the afterheating are switched off during night operation. If the temperature falls below the adjusted limit temperature at the allocated room sensor, the controller changes to the reduced heating mode.

Outdoor/Off: The heating circuit and the afterheating are switched off during night operation. If the temperature falls below the adjusted limit temperature at the allocated outdoor temperature sensor, the controller changes to the reduced heating mode.

The **Timer HC** can be used for adjusting the time frames for day operation (see page 23).

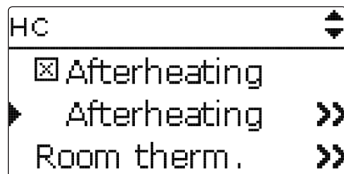

For heating circuit afterheating, the calculated set flow temperature is compared with the temperature at one reference sensor. If the temperature difference falls below the switch-on value ΔT_{on} , afterheating will be activated. If the temperature difference exceeds the switch-off value ΔT_{off} , afterheating will be switched off.

If **Thermostat** is selected, the set flow temperature is compared with a store reference sensor. If **Zone** is selected, the set flow temperature is compared with 2 reference sensors. The switching conditions at both reference sensors have to be fulfilled.

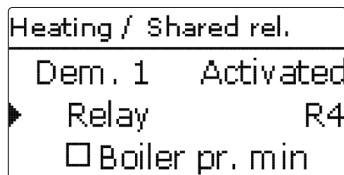

If the system has a store, the **Starting time** can be used for activating the afterheating before the day operation in order to heat the store to a sufficiently high temperature.

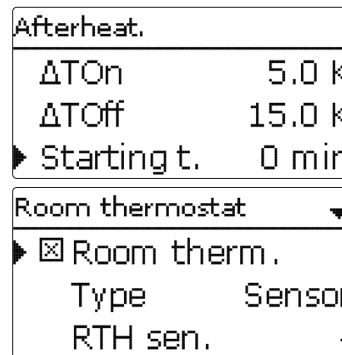

With the **Room thermostat** option, one single room can be integrated into the control logic.

A sensor input can be allocated to the room thermostat. The temperature at the allocated sensor is monitored. If the measured temperature exceeds the adjusted value **TambSet** and if the parameter **HC off** is activated, the heating circuit will switch off.

Common room thermostats with potential-free outputs can be used alternatively. In this case, **Switch** must be selected in the **Type** channel. The input S4 must previously be set to **Switch** in the **Inputs/Outputs** menu.

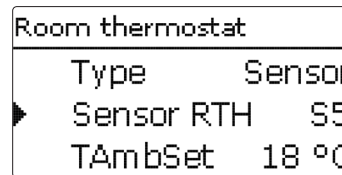

When the **Timer** option is activated, a timer is indicated in which time frames for the function can be adjusted. During these time frames, the adjusted room temperature decreases by the **Correction** value.



Note:
For information on timer adjustment see page 9.

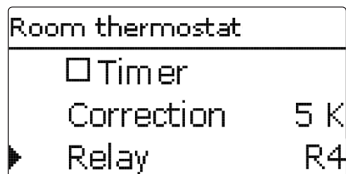

An additional relay can be allocated to the room thermostat. That relay will switch on when the temperature falls below the adjusted room temperature. This way, the room in question can be excluded from the heating circuit via a valve as long as the desired room temperature is reached.

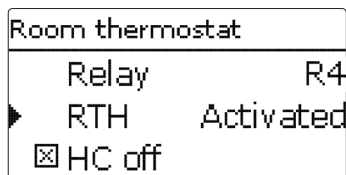

In the channel **RTH**, the room thermostat can be temporarily deactivated or re-activated respectively. All adjustments remain stored.

Antifreeze function

The antifreeze function of the heating circuit can be used to temporarily activate a heating circuit during sudden temperature drop in order to protect it against frost damage.

The temperature at the flow sensor is monitored. If the temperature falls below the adjusted antifreeze temperature **TFrost**, the heating circuit will be activated until the antifreeze temperature is exceeded by 2 K, but at least for 30 min.

Chimney sweeper function

The chimney sweeper function can be used for enabling quick access to measurement conditions without having to navigate through the menu.

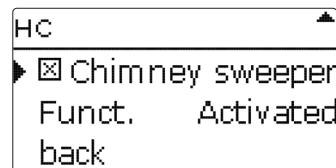

The chimney sweeper function is activated by default. The chimney sweeper mode can be activated by pressing microbutton  for 3 s.

In the chimney sweeper mode, the heating circuit mixer opens, the heating circuit pump and the afterheating contact are activated. If the chimney sweeper function is active, the Lightwheel® flashes yellow. Additionally, **Chimney sweeper** and a countdown of 30 min are indicated on the display.

When the countdown has elapsed, the chimney sweeper mode is automatically deactivated. If, during the countdown, microbutton  is again pressed for more than 3 s, the chimney sweeper mode will end.

Heating/Heating circuit

Adjustment channel	Description	Adjustment range/ selection	Factory setting
Heat. sys.	Selecting the heating system	Curve, Constant	Curve
Heating curve	Heating curve	0.3 ... 3.0	1.0
Interval	Mixer interval	1 ... 20 s	4 s
Set temp.	Set temperaturew	10 ... 100 °C	25 °C
Day correction	Temperature correction during the day	-5 ... +45 K	0 K
Night corr.	Temperature correction during the night	-20 ... +30 K	-5 K
Timer	Timer option	Yes, No	No
Mode	Correction mode selection	Day/night, Day/off, Room/Off, Outdoor/Off	Day/night
Sen. Room	Room sensor	system dependent	system dependent
TLimit	Limit temperature	-20 ... +30 °C	16 °C/0 °C
Timer HC	Heating circuit timer	Yes, No	No
Tflowmax	Maximum flow temperature	21 ... 90 °C	50 °C
Pump off	Deactivation of the heating circuit pump when Tflowmax is exceeded	Yes, No	No
Tflowmin	Minimum flow temperature	20 ... 89 °C	20 °C
TSummer	Summer temperature day	0 ... 40 °C	20 °C
Daytime on	Start time frame	00:00 ... 23:45	00:00
Daytime off	Stop time frame	00:00 ... 23:45	00:00
TNight	Summer temperature night	0 ... 40 °C	14 °C
Remote control	Remote control option	Yes, No	No
Sen. RC	Remote control sensor input selection	system dependent	system dependent
Afterheating	Afterheating option	Yes, No	No
Mode	Afterheating mode selection	Therm., Zone	Therm.
Sensor 1	Reference sensor 1	system dependent	S3
Sensor 2	Reference sensor 2	system dependent	system dependent
ΔTon	Switch-on temperature difference	-15.0 ... 44.5 K	5 K
ΔToff	Switch-off temperature difference	-14.5 ... 45.0 K	15 K
Start. time	Afterheating starting time	0 ... 120 min	0 min

Adjustment channel	Description	Adjustment range/ selection	Factory setting
Demand	Demand option	Yes, No	No
Relay	Relay selection	system dependent	system dependent
Funct.	De/activation of the afterheating	Activated, Deactivated	Activated
Room therm.	Room thermostat option	Yes, No	No
Type	Room thermostat type selection	Sensor, Switch	Sensor
RTH sen.	RTH sensor input selection	system dependent	S4
TambSet	Room temperature	10 ... 30 °C	18 °C
Timer	RTH timer	Yes, No	No
Correction	Night correction (night setback)	1 ... 20 K	5 K
Relay	RTH relay selection	system dependent	R4
RTH	Room thermostat	Activated, Deactivated	Activated
HC off	Heating circuit off option	Yes, No	Yes
TFrost	Antifreeze temperature	+4 ... +10 °C	+4 °C
Chimney sweeper	Chimney sweeper option	Yes, No	Yes
Funct.	De/activation of the heating circuit	Activ., Deactivated	Activated

6.3 Screed drying

This function is used for time- and temperature-controlled screed drying for the heating circuit.

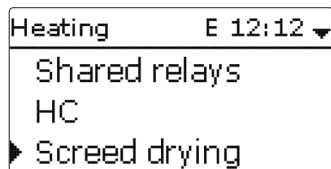

Note:

The screed drying function is blocked against the chimney sweeper function. In order to activate the screed drying function, the chimney sweeper function must be deactivated.

In the **Heating/Screed drying** menu the function can be set to standby by using the **Activated** item.

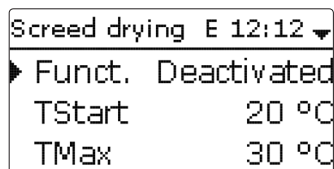

If the microbutton  is pressed and held down for at least 3 s, the screed drying programme will start.

The message **Screed drying** will be indicated on the display and the remaining time will be indicated as a countdown (dd:hh). During this process, the Lightwheel® will be flashing red.

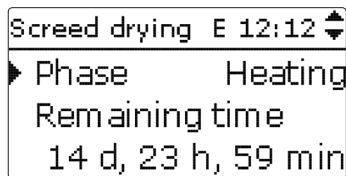

If the microbutton  is pressed again and held down for at least 3 s, the screed drying function will be cancelled. For this reason, a security enquiry appears. If you wish to interrupt the screed drying function, confirm the safety enquiry.

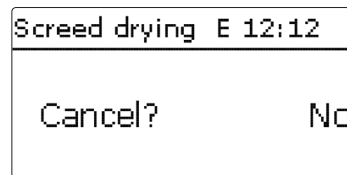

At the beginning of the screed drying function, the heating circuit is put into operation for the adjusted **Rise time** with the start temperature as the set flow temperature. Afterwards, the set flow temperature increases in steps by the adjustable rise value for the duration of the adjustable rise time until the holding temperature is reached. After the holding time has elapsed, the set flow temperature is reduced in steps until the start temperature is reached again.

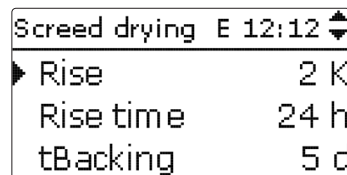

If the set flow temperature is not reached within 24 hours or after the rise time respectively, or if it is constantly exceeded, the screed drying function will be cancelled.

The heating circuit switches off and an error message is displayed. The Lightwheel® flashes red.

Error 1: flow sensor defective

Error 2: the flow temperature is higher than the maximum flow temperature + 5 K for over 5 min

Error 3: the flow temperature is higher than the holding temperature + rise value for over 30 min

Error 4: the flow temperature is higher than the set flow temperature + rise value for over 2 h

Error 5: the flow temperature is lower than the set flow temperature - rise value for over a rise time period

The left button () can be used any time for changing to the status or main menu of the controller in order to carry out adjustments.

7 Basic settings

When the screed drying function has been successfully completed, the heating circuit changes to its previously selected operating mode.

Screed drying is automatically deactivated. The chimney sweeper function is automatically activated.



Note:

Make sure the heating circuit is supplied with heat from a heat source (afterheating).



Note:

If a Micro SD card has been inserted into the slot, a screed protocol will be generated.

Heating/Screed drying

Adjustment channel	Description	Adjustment range / selection	Factory setting
Funct.	Activation / Deactivation	Activated, Deactivated	Deactivated
TStart	Start temperature	10 ... 30 °C	20 °C
TMax	Holding temperature	20 ... 60 °C	30 °C
Rise	Temperature increase per rise time	1 ... 10 K	2 K
Rise time	Duration for emperature increase	1 ... 24 h	24 h
tBacking	TMax holding time	1 ... 20 d	5 d

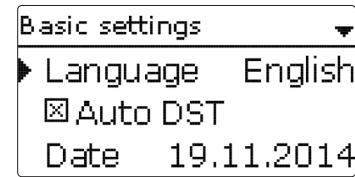

In the **Basic settings** menu, all basic parameters for the controller can be adjusted. Normally, these settings have been made during commissioning. They can be subsequently changed in this menu.

Basic settings

Adjustment channel	Description	Adjustment range / selection	Factory setting
Language	Selection of the menu language	Deutsch, English, Français, Español, Italiano, Nederlands, Türkçe, České, Polski, Portugues, Hrvatski, Română, Български, Русский, Suomi, Svenska, Magyar	Deutsch
Auto DST	Daylight savings time selection	Yes, No	Yes
Date	Adjustment of the current date	01.01.2001 ... 31.12.2099	01.01.2014
Time	Adjustment of the current time	00:00 ... 23:59	-
Temp. unit	Temperature unit	°C, °F	°C
Scheme	Scheme selection	1 ... 4	1
Reset	back to factory setting	Yes, No	No

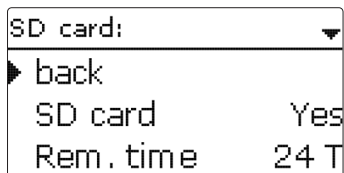

The controller is equipped with a MicroSD card slot for MicroSD memory cards. With a MicroSD card, the following functions can be carried out:

- Logging measurement and balance values. After the transfer to a computer, the values can be opened and visualised, e. g. in a spreadsheet.
- Store adjustments and parameterisations on the MicroSD card and, if necessary, retrieve them from there.
- Running firmware updates on the controller.

Running firmware updates

The current software can be downloaded from www.resol.com/firmware. When a MicroSD card with a firmware update is inserted, the enquiry **Update?** is indicated on the display.

→ In order to run an update, select **Yes** and confirm with the right button (✓).

The update is run automatically. The indication **Please wait** and a progress bar appear on the display. When the update has been completed, the controller will automatically reboot and run a short initialisation phase.



Note:

Only remove the card when the initialisation phase has been completed and the status menu is indicated on the controller display!

→ To skip the update, select **No**.

The controller starts normal operation.



Note:

The controller will only recognise a firmware update file if it is stored in a folder named **RESOL\HCM** on the first level of the MicroSD card.

→ Create a folder named **RESOL\HCM** on the MicroSD card and extract the downloaded ZIP file into this folder.

Starting the logging

→ Insert the MicroSD card into the slot.

→ Adjust the desired logging type and interval.

Logging will start immediately.

Completing the logging process

→ Select the menu item **Remove card...**

→ After **Remove card** is displayed, remove the card from the slot.

When **Linear** is adjusted in the **Logging type** adjustment channel, data logging will stop if the capacity limit is reached. The message **Card full** will be displayed.

If **Cyclic** is adjusted, the oldest data logged onto the SD card will be overwritten as soon as the capacity limit is reached.



Note:

Because of the increasing size of the data packets, the remaining logging time does not decrease linearly. The data packet size can increase, e. g. with the increasing operating hours value.

Storing controller adjustments

→ To store the controller adjustments on the MicroSD card, select the menu item **Save adjustments**.

While the adjustments are being stored, first **Please wait**, then **Done!** will be indicated on the display. The controller adjustments are stored as a .SET file on the MicroSD card.

Loading controller adjustments

→ To load controller adjustments from a MicroSD card, select the menu item **Load adjustments**.

The **File selection** window is indicated.

→ Select the desired .SET file.

While the adjustments are being loaded, first **Please wait**, then **Done!** will be indicated on the display.

9 Manual mode

Formatting the MicroSD card

→ Select the menu item **Format card**.

The content of the card will be deleted and the card will be formatted with the FAT file system.



Note:

To safely remove the MicroSD card, always select the menu item **Remove card...** before removing the card.

SD card

Adjustment channel	Description	Adjustment range/ selection	Factory setting
Remove card...	Safely remove card	-	-
Save adjustments	Save adjustments	-	-
Load adjustments	Load adjustments	-	-
Logging interval	Interval for Data logging	00:01 ... 20:00 (mm:ss)	01:00
Logging type	Logging type	Cyclic, Linear	Linear
Format card	Format card command	-	-

Manual mode	
▶ Relay 1	Auto
Relay 2	Auto
Relay 3	Auto

In the **Manual mode** menu, the operating mode of all relays of the controller can be adjusted.

All relays are listed in numerical order.

In the menu item **All relays...**, all relays can be switched off (Off) or set to automatic mode (Auto) at once:

Off = Relay is switched off (manual mode)

Auto = Relay is in automatic mode

Relay 1	
<input type="radio"/> Max	
▶ <input checked="" type="radio"/> Auto	
<input type="radio"/> Min	

The operating mode can be selected for each individual relay, too. The following options are available:

Off = Relay is switched off (manual mode)

Min. = Relay active with minimum speed (manual mode)

Max. = Relay active at 100% speed (manual mode)

Auto = Relay is in automatic mode



Note:

After service and maintenance work, the relay mode must be set back to **Auto**. Normal operation is not possible in manual mode.

Manual mode

Adjustment channel	Description	Adjustment range/ selection	Factory setting
Relay 1 ... X	Operating mode selection	Max, Auto, Min, Off	Auto
All relays...	Operating mode of all relays	Auto, Off	Off

10 User code

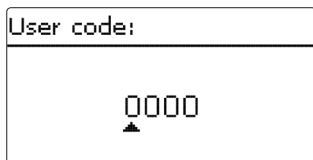

The access to some adjustment values can be restricted via a user code (customer).

1. Installer **0262** (Factory setting)

All menus and adjustment values are shown and all values can be altered.

2. Customer **0000**

The installer level is not shown, adjustment values can be changed partly.

For safety reasons, the user code should generally be set to the customer code before the controller is handed to the customer!

→ In order to restrict the access, enter 0000 in the menu item **User code**.

11 In-/Outputs

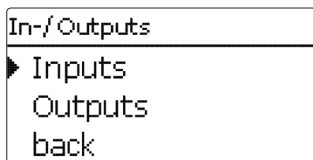

In the **In-/Outputs** menu, sensor offsets can be adjusted and relay outputs can be configured.

11.1 Inputs

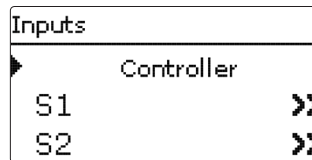

In this submenu, the type of the sensor connected can be adjusted for each individual input. The following types can be selected:

- Pt1000
- Switch (S4 only)
- RTA (S5 only)
- None

ATTENTION! System damage!



Selecting the wrong sensor type will lead to unwanted controller actions. In the worst case, system damage can occur!

→ **Make sure that the right sensor type is selected!**

If **Pt1000** has been selected, the channel **Offset** appears, in which an individual offset can be adjusted.

→ In order to select a sensor for the offset adjustment, select the corresponding menu item by pressing the right button (✓).

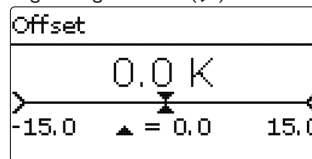

→ In order to make an adjustment, adjust the desired value with the Lightwheel® and confirm with the right button (✓).

In-/Outputs/Inputs

Adjustment channel	Description	Adjustment range/ selection	Factory setting
S1 ... S5	Sensor input selection	-	-
Type	Sensor type selection	Switch (S4 only), RTA (S5 only), Pt1000, none	Pt1000
Offset	Sensor offset	-15.0 ... +15.0 K	0,0 K
Inverted	Inverted switching option (only if Type = Switch)	Yes, No	No

11.2 Outputs

Outputs	
▶ R1	>>
R2	>>
R3	>>

In this menu, the signal type and the minimum speed can be adjusted for each relay.

➔ In order to make adjustments for a relay, select the corresponding menu item by pressing the right button (✓).

R1	
▶ Signal	Standard
Min speed	30%
back	

For each relay, the signal type and the minimum pump speed can be adjusted. The parameter Minimum speed will not be available for R4, if the signal type Standard has been selected.

The signal type determines the way speed control of a connected pump is effected. The following modes are available:

Adapter = Speed control signal via a VBus®/PWM interface adapter

0-10 V = Speed control via a 0-10V signal (R1 only)

PWM = Speed control via a PWM signal (R1 only)

Standard = Burst control (factory setting)

Speed control of a HE pump is possible via a PWM signal/0-10V control. The pump has to be connected to the relay (power supply) as well as to the PWM or 0-10V output of the controller.

If the signal type **PWM** or **0-10V** has been selected, the adjustment channel **Profile** appears. In the Profile channel, PWM characteristic curves for solar and heating pumps can be selected. (see page 73).

In the Profile channel, a PWM characteristic curve for solar pumps and a heating curve for heating pumps can be selected (see page 31).

Signal characteristic: PWM; Profile: Solar

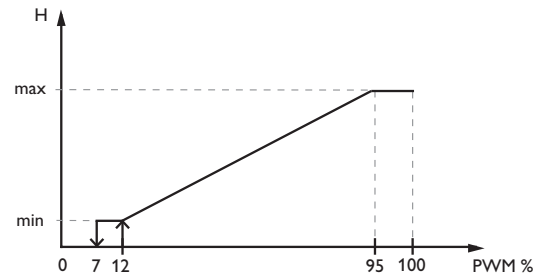

Signal characteristic: PWM; Profile: Heating

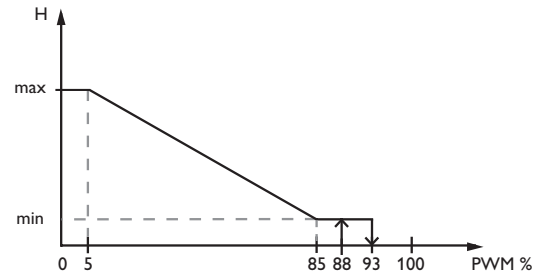

In-/Outputs/Outputs

Adjustment channel	Description	Adjustment range/selection	Factory setting
R1 ... R4	Relay output selection	-	-
Signal	Signal type	Adapter, 0-10 V (R1 only), PWM (R1 only), Standard	Standard
Profile	PWM characteristic curve	Solar, Heating	Heating
Min speed	Minimum speed	(20) 30 ... 100 %	30 %

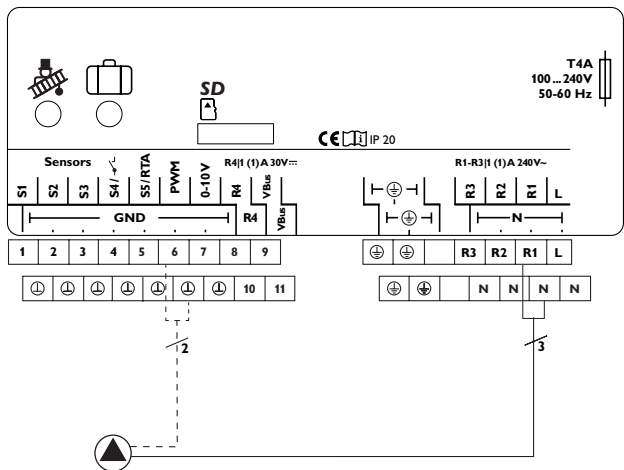

12 Troubleshooting

If a malfunction occurs, a message will appear on the display of the controller.

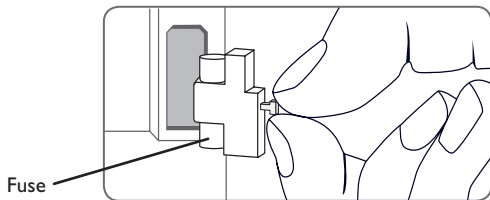

The Lightwheel® flashes red.

Sensor fault. An error code instead of a temperature is shown on the sensor display channel.

Short circuit or line break
Disconnected temperature sensors can be checked with an ohmmeter. Please check if the resistance values correspond with the table.

°C	°F	Ω Pt1000	°C	°F	Ω Pt1000
-10	14	961	55	131	1213
-5	23	980	60	140	1232
0	32	1000	65	149	1252
5	41	1019	70	158	1271
10	50	1039	75	167	1290
15	59	1058	80	176	1309
20	68	1078	85	185	1328
25	77	1097	90	194	1347
30	86	1117	95	203	1366
35	95	1136	100	212	1385
40	104	1155	105	221	1404
45	113	1175	110	230	1423
50	122	1194	115	239	1442

WARNING! Electric shock!



Upon opening the housing, live parts are exposed!

→ **Always disconnect the device from power supply before opening the housing!**

The controller is protected by a fuse. The fuse holder (which also holds the spare fuse) becomes accessible when the cover is removed. To replace the fuse, pull the fuse holder from the base.

The display is permanently off.

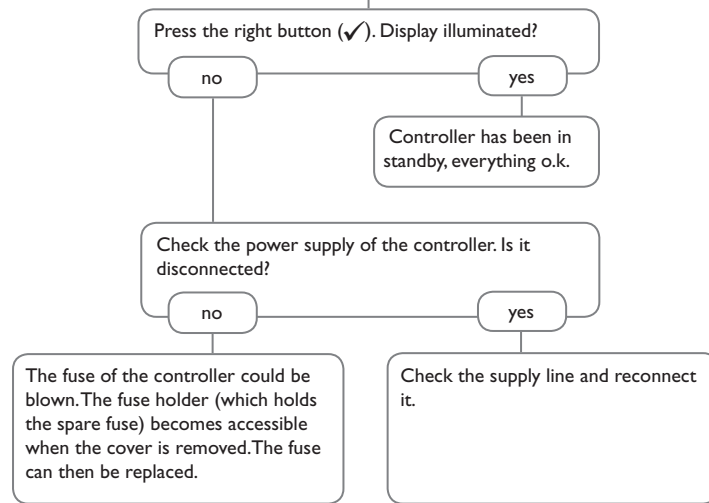

Note:

For answers to frequently asked questions (FAQ) see www.resol.com.

The heating circuit pump does not work, although this is indicated on the display.

Display illuminated?
If not, press the right button (✓).
Display illuminated again?

yes no

There is no current; check fuses / replace them and check power supply.

Does the pump start up in manual operation?

no yes

The adjusted temperature difference for starting the pump is too high; choose a value which makes more sense.

Is the pump current enabled by the controller?

no yes

Is the pump stuck?

yes

Controller might be defective - replace it.

Turn the pump shaft using a screwdriver; now passable?

no

Pump is defective - replace it.

13 Accessories

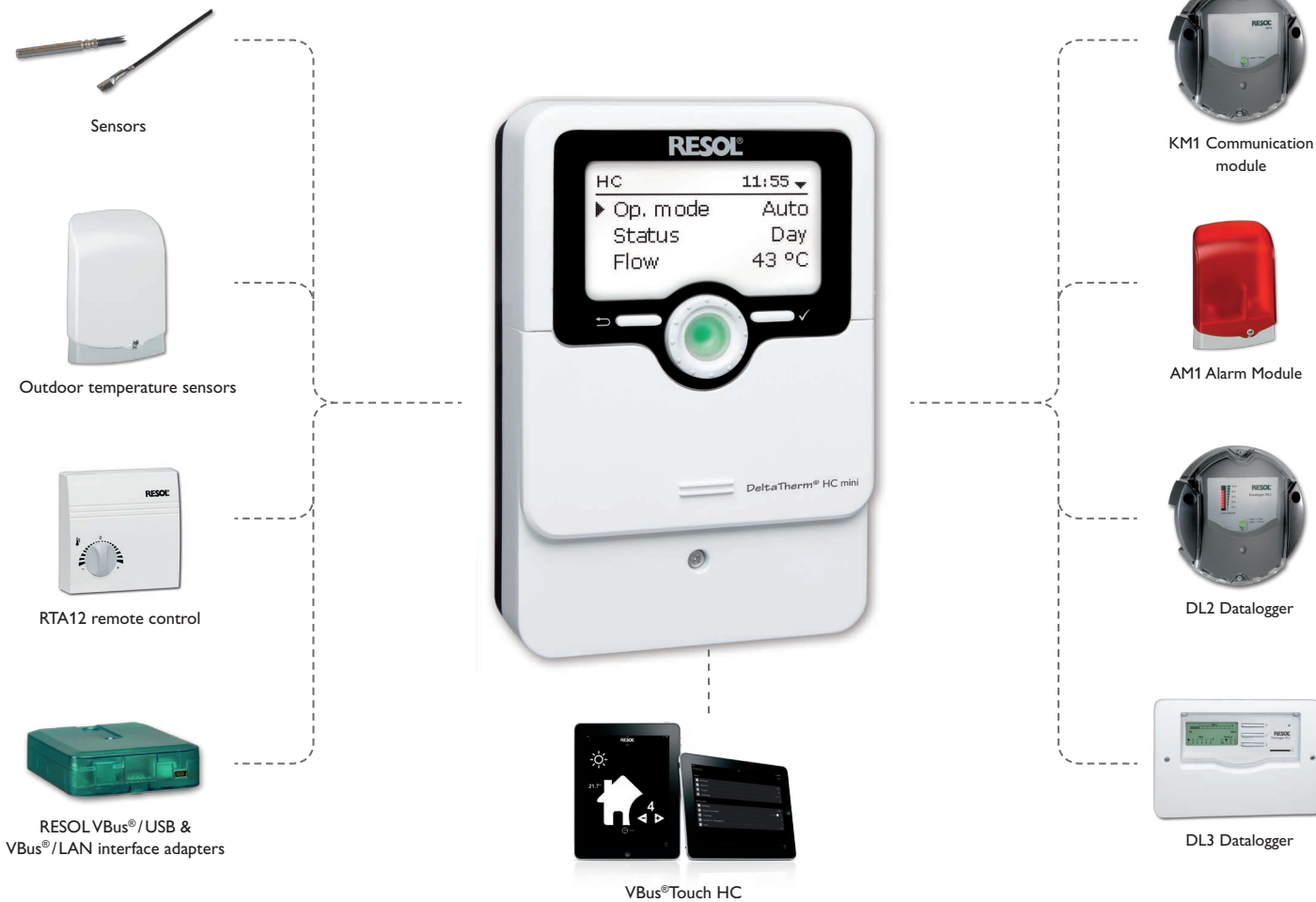

13.1 Sensors and measuring instruments

Sensors

The product range includes high-precision platinum temperature sensors, flatscrew sensors, outdoor temperature sensors, indoor temperature sensors, cylindrical clip-on sensors, also as complete sensors with immersion sleeve.

RTA12 remote control

With the RTA12, the heating curve can be comfortably adjusted from the living area.

FAP13 outdoor temperature sensor

The FAP13 is used for measuring the outdoor temperature with a Pt1000 measuring element. The FAP13 is placed in a weather-resistant housing and is designed for mounting outdoors. Cable glands for the sensor cables at the bottom of the housing allow easy installation.

13.2 VBus® accessories

AM1 Alarm Module

The AM1 Alarm Module is designed to signal system failures. It is to be connected to the VBus® of the controller and issues an optical signal via the red LED if a failure has occurred. The AM1 also has a relay output, which can e. g. be connected to a building management system (BMS). Thus, a collective error message can be issued in the case of a system failure. Depending on the controller and the sensors connected, different fault conditions can be signalled, e. g. sensor failures, excess or negative system pressure as well as errors in the flow rate, such as a dry run of the pump.

KM1 Communication module

The KM1 Communication module is the network connection for solar and heating systems, especially suited for technicians managing large systems, heating installers and home owners who like to keep a close eye on their system. The system can be parameterised over the Internet. VBus.net enables e. g. controlling the system yield in a comprehensive system scheme image.

DL3 Datalogger

Be it solar thermal, heating or DHW heat exchange controllers – with the DL3 you can easily and conveniently log system data of up to 6 RESOL controllers. Get a comprehensive overview of all controllers connected with the large full graphic display. Transfer data with a MicroSD memory card, or use the LAN interface to view and process data on your PC.

DL2 Datalogger

This additional module enables the acquisition and storage of large amounts of data (such as measuring and balance values of the system) over a long period of time. The DL2 can be configured and read-out with a standard Internet browser via its integrated web interface. For transmission of the data stored in the internal memory of the DL2 to a PC, a MicroSD card can be used. The DL2 is appropriate for all controllers with RESOL VBus®. It can be connected directly to a PC or router for remote access and thus enables comfortable system monitoring for yield monitoring or for diagnostics of faults.

VBus®Touch HC

This easy-to-use app enables you to make adjustments on your RESOL heating controller (*DeltaTherm*® HC and HC mini) from a mobile device.

Thus, e. g. the operating mode can be set via the app. Additionally, the system data are displayed in a clearly arranged graphic.



VBus® is a registered trademark of RESOL GmbH
Google Play is a trademark of Google Inc.

Apple, the Apple logo, iPad, and iPhone are trademarks of Apple Inc., registered in the U.S.

and other countries. App Store is a service mark of Apple Inc.

13.3 Interface adapters

RESOL VBus®/USB & VBus®/LAN interface adapters

The VBus®/USB interface adapter is the interface between the controller and a personal computer. With its standard mini-USB port it enables a fast transmission of system data for processing, visualising and archiving data via the VBus®. The RESOL ServiceCenter software is included.

The VBus®/LAN interface adapter is designed for the direct connection of the controller to a PC or router. It enables easy access to the controller via the local network of the owner. Thus, controller access and data charting can be effected from every workstation of the network. The VBus®/LAN interface adapter is suitable for all controllers equipped with a RESOL VBus®. The RESOL ServiceCenter software is included.

A	
Accessories.....	35
Antifreeze function.....	24
Automatic mode.....	13
B	
Balance values.....	19
Basic settings.....	27
C	
Chimney sweeper function.....	7, 24
Commissioning menu.....	12
Control lamp.....	7
Controller adjustments, loading of.....	28
Controller adjustments, storing of.....	28
Countdown.....	24
D	
Day correction.....	21
Day/Night operation.....	22
Day operation.....	23
F	
Fuse, replacing of.....	33
H	
Heating curve.....	21
Heating system.....	21
I	
Interval.....	21
L	
Lightwheel®.....	7
Limit temperature.....	22
M	
Mains supply.....	6
Maximum flow temperature.....	21
Meas. values.....	19
Messages.....	19
Microbuttons.....	7
MicroSD.....	6
Minimum flow temperature.....	21
Mixer runtime.....	21
N	
Night correction.....	21, 22
Night operation.....	22
O	
Offset.....	30
Operating mode, relays.....	29
P	
PWM pump speed control.....	31
R	
Remote control.....	21
Room thermostat.....	23
Running firmware updates.....	28
S	
Scheme.....	12
Screed drying.....	26
Sensor fault, error message.....	19
Sensor offset.....	30
Set flow temperature.....	21
Set temperature.....	21
Starting time.....	23
Start temperature.....	26
Summer mode.....	22
U	
User code.....	30

Distributed by:

RESOL – Elektronische Regelungen GmbH

Heiskampstraße 10
45527 Hattingen / Germany

Tel.: +49 (0) 23 24 / 96 48 - 0

Fax: +49 (0) 23 24 / 96 48 - 755

www.resol.com

info@resol.com

Important note

The texts and drawings in this manual are correct to the best of our knowledge. As faults can never be excluded, please note:

Your own calculations and plans, under consideration of the current standards and directions should only be basis for your projects. We do not offer a guarantee for the completeness of the drawings and texts of this manual - they only represent some examples. They can only be used at your own risk. No liability is assumed for incorrect, incomplete or false information and / or the resulting damages.

Note

The design and the specifications can be changed without notice.

The illustrations may differ from the original product.

Imprint

This mounting- and operation manual including all parts is copyrighted. Another use outside the copyright requires the approval of RESOL – Elektronische Regelungen GmbH. This especially applies for copies, translations, micro films and the storage into electronic systems.

© **RESOL – Elektronische Regelungen GmbH**